

# PoolOne

INSTALLATION MANUAL

EN

HANDBUCH

DE

MANUAL DE INSTALACION

ES

MANUEL D'INSTALLATION

FR

MANUALE D'INSTALLAZIONE

IT



# PoolOne Peristaltic Pump | Models: CS · RG · pH · ORP

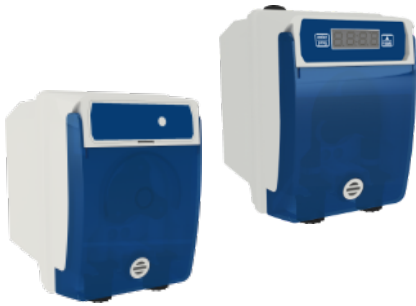

**WARNING!**

Before carrying out ANY work inside control panel of the PoolOne device, make sure you disconnect it from the power supply.

Failure to comply with the instructions contained in this manual could cause injury to people and/or damage to the appliance and the system.

## 1 PACKAGE CONTENT

 <b>A:</b> Reducer for injection valve (1/2" M to 3/8" F)	 <b>B:</b> PVC Crystal 4x6 with suction hose (4 m)	 <b>C:</b> Polyethylene delivery hose (5m)	 <b>D:</b> Tapping saddle for securing PSS3 onto 2" hose (φ=50 mm)
 <b>E:</b> Foot filter (PP riser)	 <b>F:</b> FPM Lip valve (3/8" GAS)	 <b>G:</b> PSS3 probe-holder (1/2" GAS)	 <b>H:</b> Mounting bracket kit (φ=6 mm screws)
 <b>I:</b> pH probe	 <b>J:</b> ORP probe	 <b>K:</b> pH 7 Buffer solution	 <b>L:</b> 465 mv Calibration solution

Model Item*	PoolOne CS (constant dosing)	PoolONE RG (Analogic regulation pump)	PoolONE RG-DIGIT (Digital regulation pump)	PoolOne pH (3.8 – 8.2 pH)	PoolOne ORP (400 – 999 mV)
<b>A</b>	1	1	1	1	1
<b>B</b>	1	1	1	1	1
<b>C</b>	1	1	1	1	1
<b>D</b>	1	1	1	2	2
<b>E</b>	1	1	1	1	1
<b>F</b>	1	1	1	1	1
<b>G</b>	---	---	---	1	1
<b>H</b>	1	1	1	1	1
<b>I</b>	---	---	---	1	---
<b>J</b>	---	---	---	---	1
<b>K</b>	---	---	---	---	1
<b>L</b>	---	---	---	1	---

\* The values from the table represent the number of items inside of the package.

# PoolOne Peristaltic Pump | Models: CS · RG · pH · ORP

## WARNING!

These products are **DANGEROUS (I★A)** and require special precautions during use, handling and storage.

- **NEVER mix chemical products.**
- **NEVER** allow children or people who have not read this manual to use or tamper with PoolOne or any of its peripheral components (including chemical products).

### pH chemical products:

- **ABSOLUTELY** not recommended => pure sulphuric acid
- Recommended for lowering pH => negative pH (with a sulphuric acid base)
- Recommended for raising pH => positive pH (sodium carbonate or bicarbonate)

### ORP chemical products:

- **ABSOLUTELY** not recommended => all types of organic chlorine
- Liquid chlorine or 12% bleach can be used neat. If the product has a concentration of 48%, it is necessary to dilute it in water in a 1:3 ratio.

The pH / ORP probes are subject to wear and tear and therefore are not covered by the warranty.

## 2 INSTALLATION INSTRUCTIONS

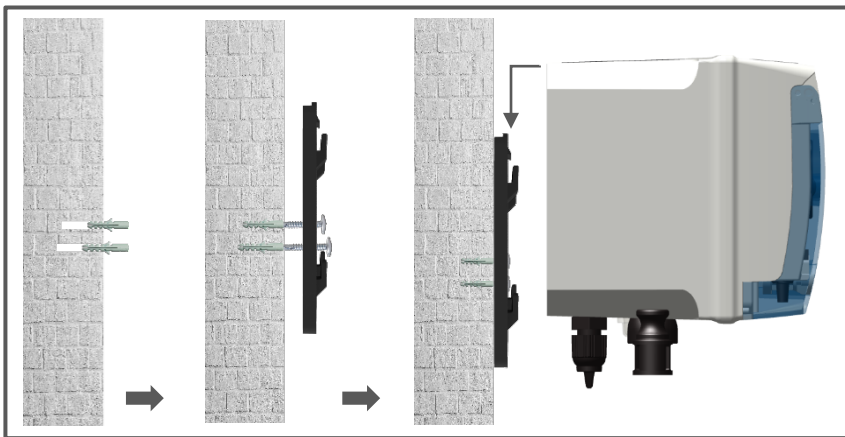

Make sure that the injection pressure is below 1.5 bar

### Probe positioning

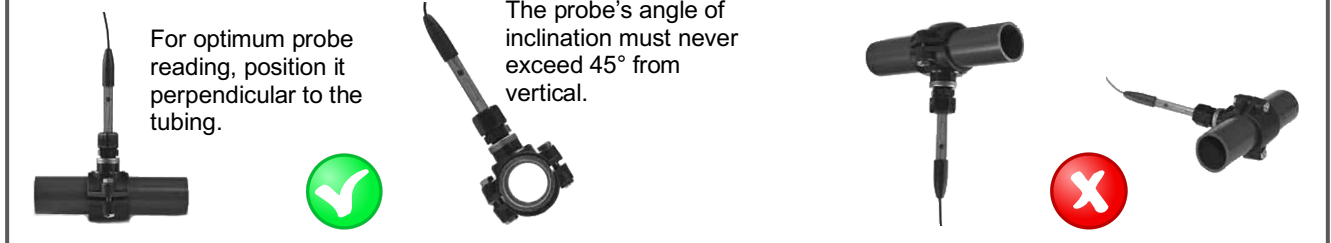

### Installation plant

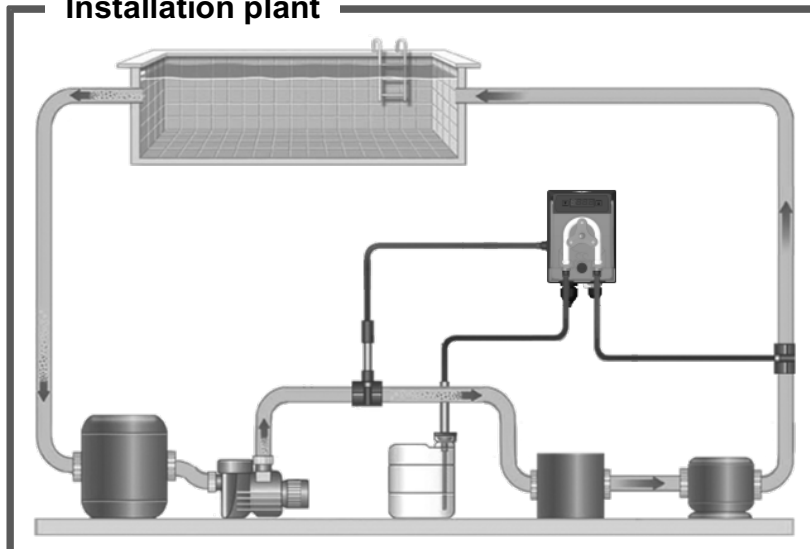

### Warning!

#### Use with salt chlorinator:

For the pH systems, to prevent the risk of system malfunctioning or damage, observe the following instructions:

1. Position the pH measuring probe prior to the chlorinator cell.
2. To eliminate eddy currents, connect the pool water to an electrical ground point
3. Position the product injection point after the chlorinator cell.

# PoolOne Peristaltic Pump | Models: CS · RG · pH · ORP

## 3 ELECTRICAL CONNECTIONS

### Wiring diagram:

1. Switch with three positions: ON-OFF-MOM
2. Power Supply cord cable
3. pH or ORP probe input, with BNC connector
4. Free

Connect the power supply pre-wired cable to the mains (100 ÷ 240 Vac).

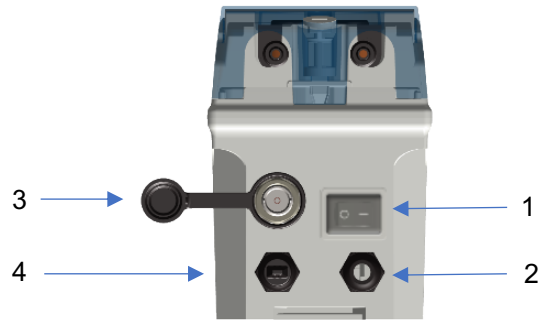

## 4 TECHNICAL SPECIFICATIONS

Specifications	PoolOne CS	PoolOne pH	PoolOne ORP	PoolOne RG	PoolONE RG-Digit
Range	---	3.2 ÷ 8.2 pH (*1)	400÷999 mV (*1)	---	---
Accuracy	---	± 0.02 pH	± 2 mV	---	---
Device precision	---	± 0.1 pH	± 10 mV	---	---
Pump flow rate	1.5 or 5 l/h	1.5 l/h	1.5 l/h	4 l/h	25 to 9450 ml/h
Power supply	220 - 240 Vac 50/60 Hz				100 ÷ 240 Vac 50/60 Hz
Consumption	9 Watt				
Dosage method	Constant dosing	ON-OFF Set Point adjustable		Constant dosing adjust by trimmer	Constant dosing adjust by digit
Pump state	Pause – Supply				
Display	None	4 digits with 7 segments		None	4 digits with 7 segments
Probe calibration	None	Automatic		None	None
Max. back-pressure	1.5 bar				
Weight	1.3 kg				
Dimensions (W–H–D)	98 x 134 x 118 mm (3.85" x 5.3" x 4.6")				

(\*1) The pump has galvanised electrical insulation and measure insulation.

### Labels Product:

1. Code and serial number
2. QR Code to download full instruction manual.

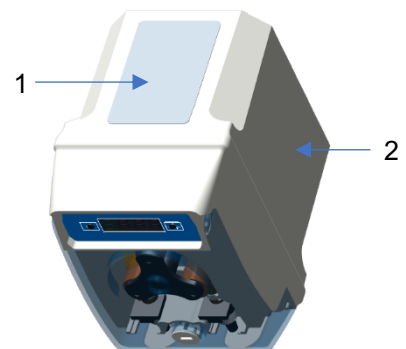

# PoolOne Peristaltic Pump | Models: CS · RG · pH · ORP

## 5 SETUP AND OPERATION

### 5.1 PoolONE CS

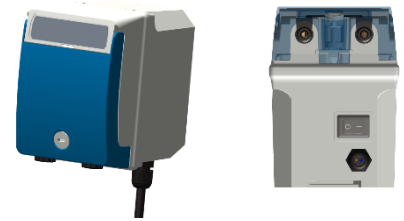

PoolONE CS: constant dosing pump without flowrate regulation

### 5.2 PoolONE RG Analogic Pump

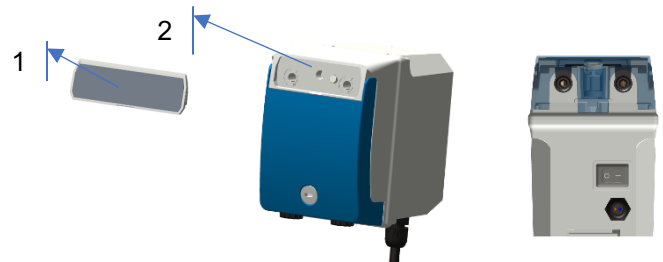

PoolONE RG: constant dosing pump with flowrate regulation by trimmer

Remove the plastic cover (1) and adjust flowrate by trimmer (2).  
Min flowrate is 35% of the maximum value.

### 5.3 PoolOne RG-DIGITAL Pump



#### Wiring diagram:

1. Switch with three positions: ON-OFF-MOM
2. Power Supply cord cable
3. Circulation pump 220-240 VAC input
4. Free

PoolONE RG-Digit: constant dosing pump with flowrate regulation by keyboard  
Min flowrate is 10% of the maximum value.

#### Switch position:

- MOM:** Priming position. The pump runs for 3 minutes at max speed; pressing again the MOM switch stops the pump.
- ON:** Normal position. The unit doses.  
Pump starts dosing at the set speed when an external trigger is detected and stops dosing when the external trigger is undetected.  
For setting the pump speed, press ▼ or ▲ to adjust the speed from 10 to max. 100%.
- OFF:** Stand by position. The pump is stopped.

# PoolOne Peristaltic Pump | Models: CS · RG · pH · ORP

## 5.4 PoolOne pH

Constant dosing with pH control meter built in, the pump has galvanised electrical insulation and measure insulation.



### Switch position:

- MOM:** Priming position. The pump is running.
- ON:** Normal position. The unit measures the pH and doses.
- OFF:** Stand by position. The pump is stopped.

### Setup

- Set the switch to **OFF** position.
- Keep pressed **cal** for 3 seconds to enter the SETUP menu.
- pH setup menu:
  - Adjust the dosage method for pH: **Acid** or **Alka**
  - Temperature (fixed value): **25°C**

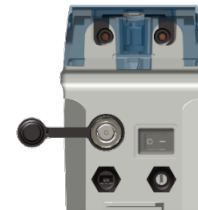

### Set Point adjustment

- Set the switch to **ON** position.
- Keep pressed **set** until the Setpoint value starts flashing, then press again **set** to increase the value.
- After 3 seconds from releasing the **set** key, the unit saves the value and displays **mem**.  
It is possible to set a value between 3.2 and 8.2 pH, with an increase of 0.1 pH.  
When the real measure is lower than 3.2 pH or higher than 8.2 pH, the measure displayed flashes.

Set the switch to **ON** position then follow the steps below:

<p>1</p>	<p>2</p>	<p>3</p>	<p>4</p>
<p>5</p> <p>Set pH calibration</p>	<p>6</p>	<p>7</p> <p>60 s</p>	<p>8</p>
<p>9</p>	<p>10</p>	<p>11</p> <p>Save and exit</p>	

**Note:** If you have selected the EasyCal function, the calibration will be made only in 1 point using the 7 pH buffer solution. During calibration procedure, the **hold (setup)** LED will turn red.

# PoolOne Peristaltic Pump | Models: CS · RG · pH · ORP

## 5.5 PoolOne ORP

Constant dosing with pH control meter built in, the pump has galvanised electrical insulation and measure insulation



### Switch position:

- MOM**: Priming position. The pump is running.
- ON**: Normal position. The unit measures the ORP and doses.
- OFF**: Stand by position. The pump is stopped.

### Setup

- Set the switch to **OFF** position.
- Keep pressed **cal** for 3 seconds to enter the SETUP menu.
- ORP setup menu:
  - Adjust the dosage method for ORP: **High** ("Hi") or **Low** ("Lo")
  - Temperature (fixed value): **25°C**

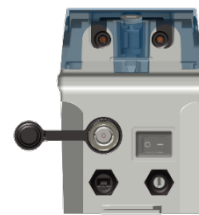

### Set Point adjustment

- Set the switch to **ON** position.
- Keep pressed **set** until the Setpoint value starts flashing, then press again **set** to increase the value.
- After 3 seconds from releasing the **set** key, the unit saves the value and displays **mem**.  
It is possible to set a value between 400 and +999 mV, with an increase of 10 mV.  
When the real measure is lower than 400 mV or higher than 999 mV, the measure displayed flashes.

Set the switch to **ON** position then follow the steps below:

<p>1</p>	<p>2</p>	<p>3</p>	<p>4</p>
<p>5</p> <p>Set Redox calibration</p>	<p>6</p>	<p>7</p> <p>60 s</p>	<p>8</p>
<p>9</p>	<p>10</p>	<p>11</p> <p>Save and exit</p>	

**Note:** During calibration procedure, the **hold (setup)** LED will turn red.



# PoolOne Peristaltic Pump | Models: CS · RG · pH · ORP

## 6 ALARMS

### 6.1 PoolOne CS

- Alarm

### 6.2 PoolOne pH

- **OFA Alarm** (Overfeed Alarm)
- **Flow:** presence of incoming flow (enslavement by the filter pump).

### 6.3 PoolOne ORP

- **OFA Alarm** (Overfeed Alarm):
- **Flow:** presence of incoming flow (enslavement by the filter pump).

- **LEVEL ALARM (OPTIONAL)**

If the pump signals a level alarm, the display shows: **FLR** and the buzzer comes on.

Alarm	PoolOne pH	PoolOne ORP	Actions to do
<b>Out of Range measure</b>	<b>888</b> (flashing)	<b>888</b> (flashing)	<ul style="list-style-type: none"><li>• Replace or check the measure probe</li><li>• Press <b>cal</b> to open Alarm Relay</li><li>• Restore pH / ORP</li></ul>

## 7 HANDLING

### Hose replacement:

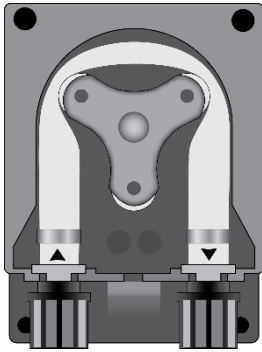

Open the pump's lid and release the hose by pulling the left connector upward.

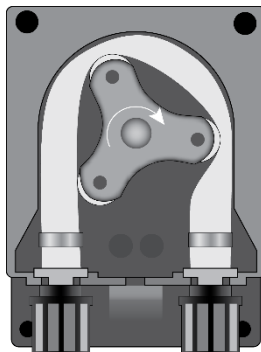

Position the roller at 7h15, turning it in the direction of the circular arrow.

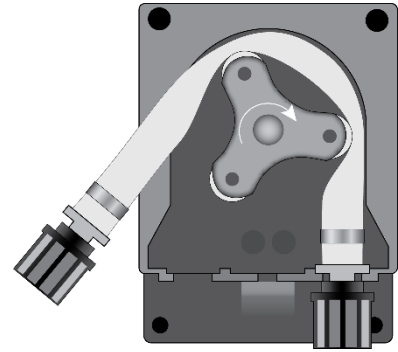

Completely release the left connector, holding it taut towards the outside, and turn the roller in the direction of the circular arrow so that the hose is freed up to the right connector.

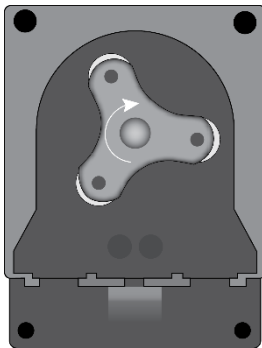

Position the roller at 7h15, turning it in the direction of the circular arrow.

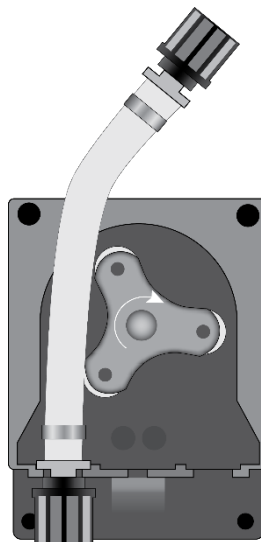

Insert the left connector into the relative housing and pass the hose under the roller's guide. Turn the roller in the direction of the circular arrow, simultaneously accompanying the hose into the pump's head, until the right connector is reached.

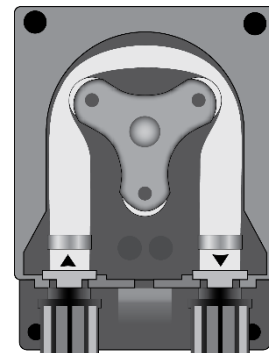

Close the pump's lid and press its surface hard so that it is properly locked into place.

# PoolOne Schlauchpumpe | Modelle: CS · RG · pH · ORP

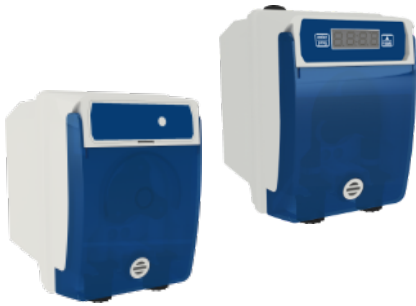

## ACHTUNG!

Vor jeder Maßnahme innerhalb der Steuertafel des PoolOne ist sicherzustellen, dass diese Vorrichtung vom Netz getrennt ist.

Die Nichteinhaltung der in dieser Anleitung enthaltenen Anweisungen kann zu Personenschäden, Schäden am Gerät und Schäden am System führen.

## 1 LIEFERUMFANG

 <p><b>A:</b> Reduzierstück für Einspritzventil (1/2" außen auf 3/8" innen)</p>	 <p><b>B:</b> PVC Crystal 4x6 mit Ansaugschlauch (4 m)</p>	 <p><b>C:</b> Polyäthylen-Auslassschlauch (5m)</p>	 <p><b>D:</b> Selbstschneidende Rohrschlauchklemme zum Befestigen des PSS3 auf dem 2"-Schlauch (φ=50 mm)</p>
 <p><b>E:</b> Fußfilter (PP-Rohr)</p>	 <p><b>F:</b> FPM-Lippenventil (3/8" GAS)</p>	 <p><b>G:</b> PSS3-Sondenträger(1/2" Gas)</p>	 <p><b>H:</b> Halterungssatz (φ=6 mm-Schrauben)</p>
 <p><b>I:</b> pH-Sonde</p>	 <p><b>J:</b> ORP-Sonde</p>	 <p><b>K:</b> Pufferlösung pH 7</p>	 <p><b>L:</b> Kalibrierlösung 465 mV</p>

Modell Artikel*	PoolOne CS (konstante Dosierung)	PoolONE RG (Analoge Regelpumpe)	PoolONE RG-DIGIT (Digitale Regelpumpe)	PoolOne pH (3.8 – 8.2 pH)	PoolOne ORP (400 – 999 mV)
A	1	1	1	1	1
B	1	1	1	1	1
C	1	1	1	1	1
D	1	1	1	2	2
E	1	1	1	1	1
F	1	1	1	1	1
G	---	---	---	1	1
H	1	1	1	1	1
I	---	---	---	1	---
J	---	---	---	---	1
K	---	---	---	---	1
L	---	---	---	1	---

\* Die Zahlen in der Tabelle geben die Anzahl der jeweiligen Artikel im Lieferumfang an.

# PoolOne Schlauchpumpe | Modelle: CS · RG · pH · ORP

## ACHTUNG!

Diese Produkte sind **GEFÄHRLICH (I✳A)** und deren Umgang, Gebrauch und Lagerung erfordern besondere Vorsichtsmaßnahmen.

- **Chemikalien NIEMALS miteinander vermischen.**
- Niemals Kinder oder mit dieser Anleitung nicht vertraute Personen die PoolOne oder zugehörige Komponenten einschließlich der Chemikalien verwenden oder damit hantieren lassen.

### pH-Werte der Chemikalien:

- **ABSOLUT** nicht empfohlen => reine Schwefelsäure
- Zum Senken des pH-Werts wird ein negativer pH-Wert empfohlen (auf der Grundlage von Schwefelsäure)
- Zum Erhöhen des pH-Werts wird ein positiver pH-Wert empfohlen (Natriumcarbonat oder Bicarbonat)

### ORP-Werte der Chemikalien:

- **ABSOLUT** nicht empfohlen => Alle Arten organischer Chlorverbindungen
- Flüssige Chlorverbindungen und 12%-Bleichmittel sind ohne weiteres verwendbar. Mittel mit 48%-iger Konzentration müssen im Verhältnis 1:3 in Wasser gelöst werden.

Alle pH- und ORP-Sonden sind Verschleißteile und daher von jeglicher Garantie ausgeschlossen.

## 2 EINBAUANLEITUNG

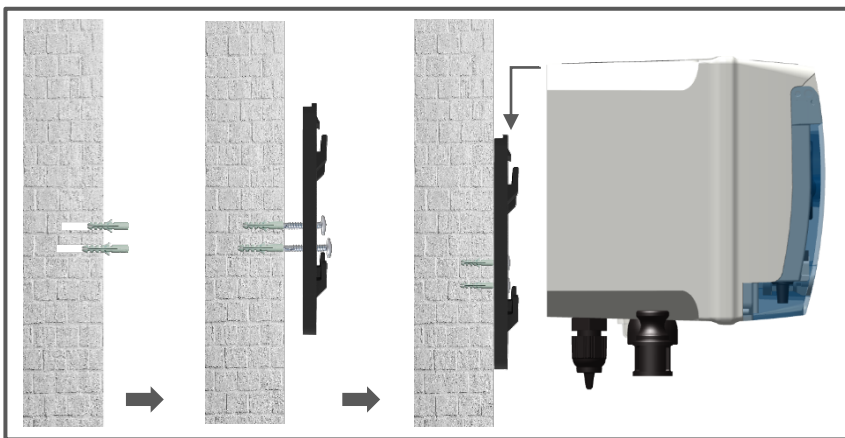

Vergewissern Sie sich, dass der Einspritzdruck weniger als 1,5 bar beträgt

### Positionierung der Messsonde

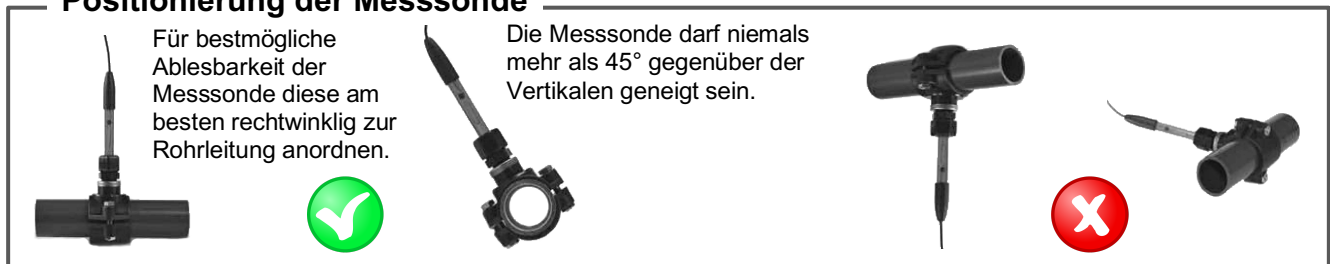

### Anlagenaufbau

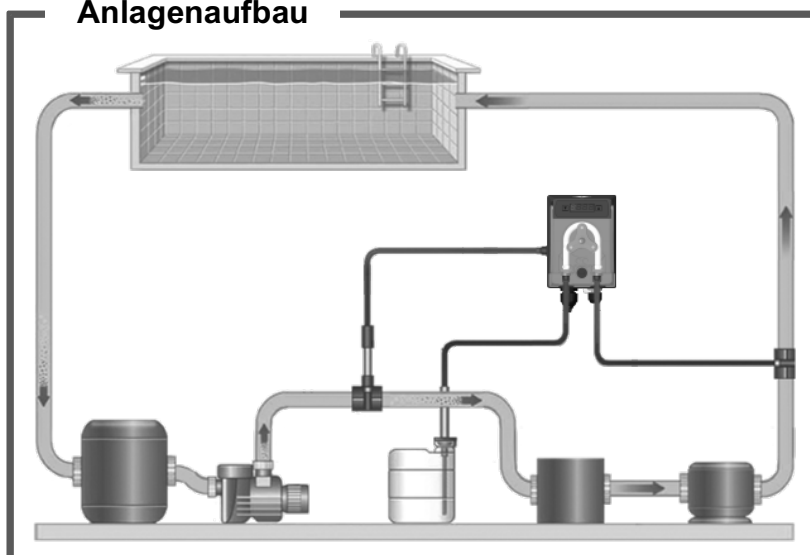

### Achtung!

#### Verwendung mit Salzchlorungsmittel:

Um bei pH-Systemen Systemstörungen und Systemschäden vorzubeugen, ist Folgendes zu beachten:

1. Die pH-Messsonde vor der Chlorierungszelle positionieren.
2. Zur Vermeidung von Fehlerströmen das Poolwasser erden.
3. Den Einspritzzeitpunkt für das Mittel hinter der Chlorierungszelle anordnen.

# PoolOne Schlauchpumpe | Modelle: CS · RG · pH · ORP

## 3 ELEKTRISCHE ANSCHLÜSSE

### Schaltplan:

1. 3-Positionen-Schalter: ON-OFF-MOM
2. Stromversorgungskabel
3. pH oder ORP-Sonde Eingang, mit BNC-Verbinder
4. Frei

Das vorgefertigte Netzstromkabel an das Netz (100 ÷ 240 Vac) anschließen.

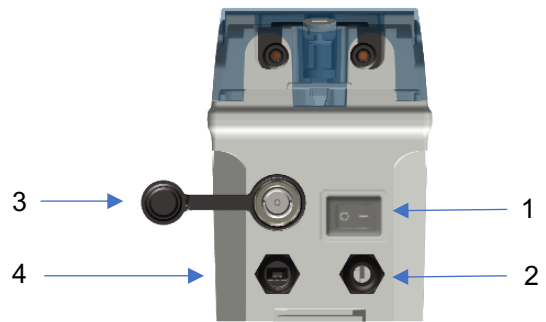

## 4 TECHNISCHE DATEN

Daten	PoolOne CS	PoolOne pH	PoolOne ORP	PoolOne RG	PoolONE RG-Digit
Bereich	---	3.2 ÷ 8.2 pH (*1)	400÷999 mV (*1)	---	---
Genauigkeit	---	± 0,02 pH	± 2 mV	---	---
Genauigkeit des Geräts	---	± 0,1 pH	± 10 mV	---	---
Durchfluss Pumpe	1.5 oder 5 l/h	1.5 l/h	1.5 l/h	4 l/h	25 bis 9450 ml/h
Stromversorgung	220 - 240 Vac 50/60 Hz				100 ÷ 240 Vac 50/60 Hz
Verbrauch	9 Watt				
Dosiermethode	Konstante Dosierung	EIN-AUS Sollwert einstellbar		Konstante Dosiereinstellung mittels Trimmer	Konstante Dosiereinstellung mittels Zahlen
Pumpenstatus	Unterbrechung - Ein				
Display	Keine	4 Zahlen mit 7 Segmenten		Keine	4 Zahlen mit 7 Segmenten
Sondenkalibrierung	Keine	Automatisch		Keine	Keine
Max. Gegendruck	1,5 bar				
Gewicht	1,3 kg				
Abmessungen (B-H-T)	98 x 134 x 118 mm (3.85" x 5.3" x 4.6")				

(\*1) Die Pumpe hat eine verzinkte Strom- und Messisolierung.

### Label Produkt:

1. Code und Seriennummer
2. QR-Code zum Herunterladen des kompletten Handbuchs.

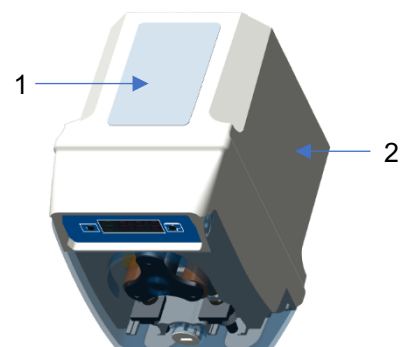

# PoolOne Schlauchpumpe | Modelle: CS · RG · pH · ORP

## 5 SETUP UND BETRIEB

### 5.1 PoolONE CS



PoolONE CS: Konstante Dosierpumpe ohne Durchflussregelung

### 5.2 PoolONE RG Analoge Pumpe

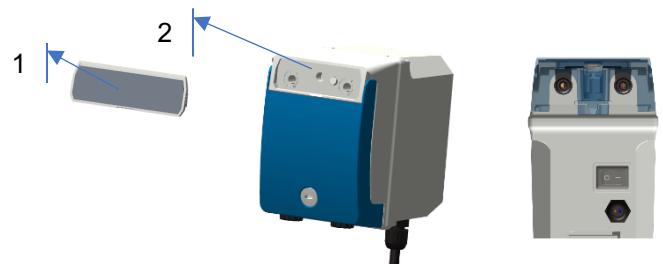

PoolONE RG: Konstante Dosierpumpe mit Durchflussregelung mittels Trimmer

Den Plastikdeckel (1) abnehmen und die Durchflussrate mittels Trimmer (2) regeln.  
Die minimale Durchflussrate entspricht 35% des maximalen Werts.

### 5.3 PoolOne RG-DIGITAL Pumpe

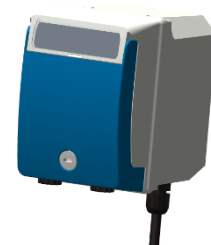

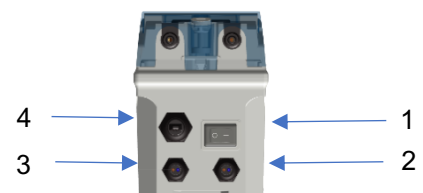

#### Schaltplan:

1. 3-Positionen-Schalter: ON-OFF-MOM
2. Stromversorgungskabel
3. Umwälzpumpe 220-240 VAC Eingang
4. Frei



PoolONE RG-Digit: Konstante Dosierpumpe mit Durchflussregelung mittels Tastatur  
Die minimale Durchflussrate entspricht 10% des maximalen Werts.

#### Schalterposition:

- MOM:** Vorbereitungsposition. Die Pumpe läuft für 3 Minuten bei maximaler Geschwindigkeit; durch erneutes Drücken des MOM-Schalters wird die Pumpe gestoppt.
- EIN:** Normale Position. Die Einheit dosiert.  
Die Pumpe startet die Dosierung bei eingestellter Geschwindigkeit, wenn ein externer Trigger erkannt wird, und stoppt die Dosierung, wenn kein externer Trigger erkannt wird.  
Zum Einstellen der Geschwindigkeit der Pumpe  oder  drücken, um die Geschwindigkeit von 10 bis max. 100% zu regeln.
- AUS:** Standby-Position. Die Pumpe steht still.

# PoolOne Schlauchpumpe | Modelle: CS · RG · pH · ORP

## 5.4 PoolOne pH

Konstante Dosierung mit eingebautem pH-Messgerät, die Pumpe hat eine verzinkte Strom- und Messisolierung.



### Schalterposition:

- MOM:** Vorbereitungsposition. Die Pumpe läuft.
- EIN:** Normale Position. Die Einheit misst den pH-Wert und dosiert.
- AUS:** Standby-Position. Die Pumpe steht still.

### Setup

- Den Schalter auf Position **AUS** stellen.
- Die Taste **cal** 3 Sekunden lang gedrückt halten, um das SETUP-Menü aufzurufen.
- pH Setup-Menü:
  - Die pH-Dosiermethode einstellen: **Sauer** oder **Alka**
  - Temperatur (fester Wert): **25°C**



### Sollwerteinstellung

- Den Schalter auf Position **EIN** stellen.
- Die Taste **set** gedrückt halten, bis der Sollwert zu blinken beginnt, dann erneut **set** drücken, um den Wert zu erhöhen.
- 3 Sekunden nach Freigabe der Taste **set**, speichert die Einheit den Wert und zeigt „mem“ an. Es ist möglich, einen Wert zwischen 3.2 und 8.2 pH in Schritten von 0.1 pH einzustellen. Wenn der reale Messwert niedriger als 3.2 pH oder höher als 8.2 pH ist, beginnt er zu blinken.

Den Schalter auf Position **EIN** stellen und die folgenden Schritte ausführen:

<b>1</b>	<b>2</b>	<b>3</b>	<b>4</b>
<b>5</b> pH-Kalibrierung einstellen	<b>6</b>	<b>7</b> 60 s	<b>8</b>
<b>9</b>	<b>10</b>	<b>11</b> Speichern und Verlassen	

**Hinweis:** Wenn die Funktion „EasyCal“ eingestellt wurde, wird nur an einem (1) Punkt kalibriert, und zwar mithilfe der Pufferlösung pH 7. Während des Kalibrierens leuchtet die LED **Halten (Setup)** rot.

# PoolOne Schlauchpumpe | Modelle: CS · RG · pH · ORP

## 5.5 PoolOne ORP

Konstante Dosierung mit eingebautem pH-Messgerät, die Pumpe hat eine verzinkte Strom- und Messisolierung



### Schalterposition:

- MOM:** Vorbereitungsposition. Die Pumpe läuft.
- EIN:** Normale Position. Die Einheit misst den ORP und dosiert.
- AUS:** Standby-Position. Die Pumpe steht still.

### Setup

- Den Schalter auf Position **AUS** stellen.
- Die Taste **cal** 3 Sekunden lang gedrückt halten, um das SETUP-Menü aufzurufen.
- ORP Setup-Menü:
  - Die pH-Dosiermethode einstellen: **Hoch** („Hi“) oder **Niedrig** („Lo“)
  - Temperatur (fester Wert): **25°C**

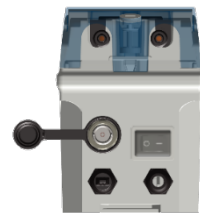

### Sollwerteinstellung

- Den Schalter auf Position **EIN** stellen.
- set** gedrückt halten, bis der Sollwert zu blinken beginnt, dann erneut **set** drücken, um den Wert zu erhöhen.
- 3 Sekunden nach Freigabe der Taste **set**, speichert die Einheit den Wert und zeigt „mem“ an. Es ist möglich, einen Wert zwischen 400 und +999 mV in Schritten von 10 mV einzustellen. Wenn der reale Messwert niedriger als 400 mV oder höher als 999 mV ist, beginnt er zu blinken.

Den Schalter auf Position **EIN** stellen und die folgenden Schritte ausführen:

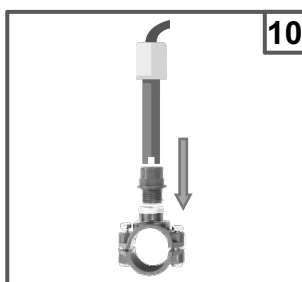
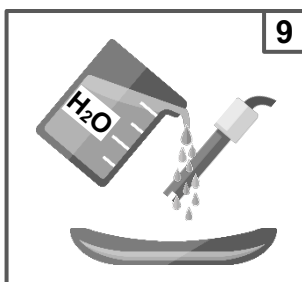
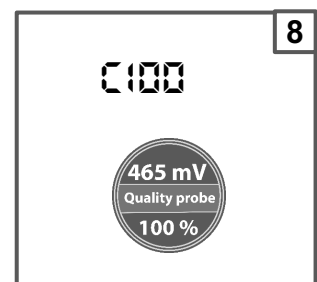
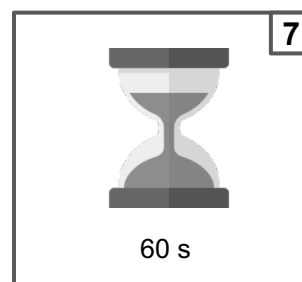
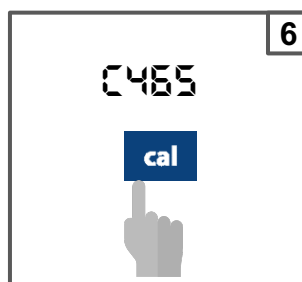
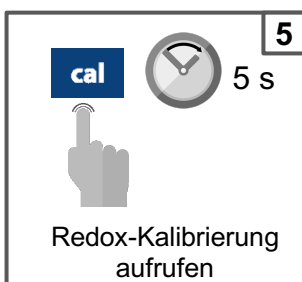
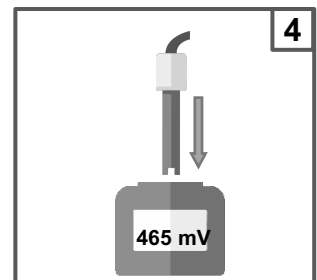
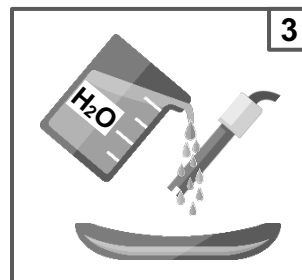
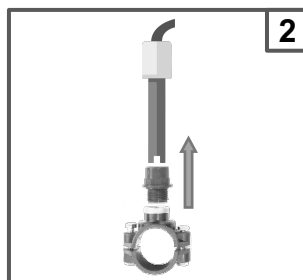
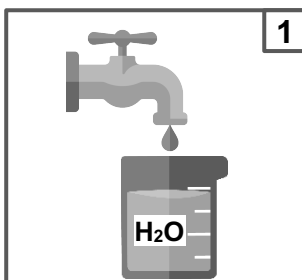

**Hinweis:** Während des Kalibrierens leuchtet die LED **Halten (Setup)** rot.



# PoolOne Schlauchpumpe | Modelle: CS · RG · pH · ORP

## 6 ALARME

### 6.1 PoolOne CS

- Alarm

### 6.2 PoolOne pH

- **OFA-Alarm** (Alarm Überflutung)
- **Durchfluss:** Es erfolgt aufgrund der Wirkung der Filterpumpe ein Zufluss.

### 6.3 PoolOne ORP

- **OFA-Alarm** (Alarm Überflutung):
- **Durchfluss:** Es erfolgt aufgrund der Wirkung der Filterpumpe ein Zufluss.
- **FÜLLSTAND-ALARM (OPTIONAL)**  
Falls die Pumpe einen Füllstand-Alarm meldet, wird angezeigt: **RLR** und der Summer schaltet sich ein.

Alarm	PoolOne pH	PoolOne ORP	Maßnahmen
<b>Messung außerhalb des Arbeitsbereichs</b>	<b>888</b> (blinkend)	<b>888</b> (blinkend)	<ul style="list-style-type: none"><li>• Den Messfühler prüfen oder ersetzen</li><li>• Zum Öffnen des Alarmrelais <b>cal</b> drücken</li><li>• pH / ORP wiederherstellen</li></ul>

## 7 HANDHABUNG

### Ersetzen der Schläuche:

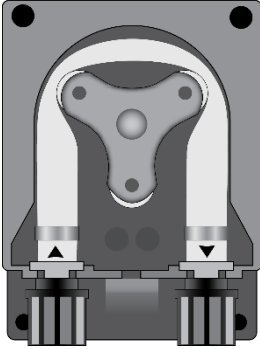

Den Pumpendeckel öffnen und den Schlauch durch Hochziehen des linken Anschlusses freigeben.

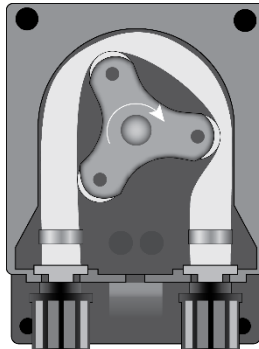

Den Rotor auf „7:15 Uhr“ stellen, dazu in Richtung des kreisförmigen Pfeils drehen.

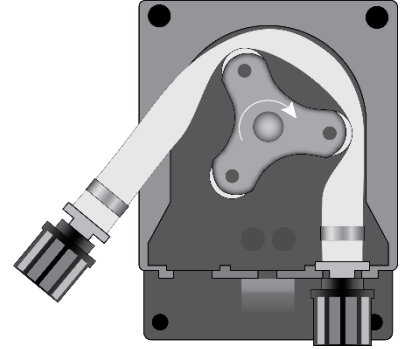

Den linken Anschluss vollständig freigegeben und dabei leicht nach außen ziehen. Den Läufer in Richtung des kreisförmigen Pfeils drehen, so dass der Schlauch am rechten Anschluss freigegeben wird.

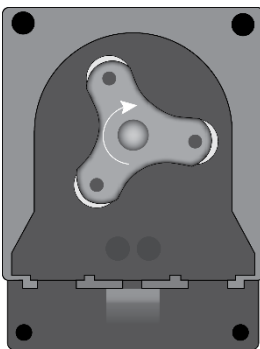

Die Läufer auf 7:15 Uhr stellen, dazu in Richtung des kreisförmigen Pfeils drehen.

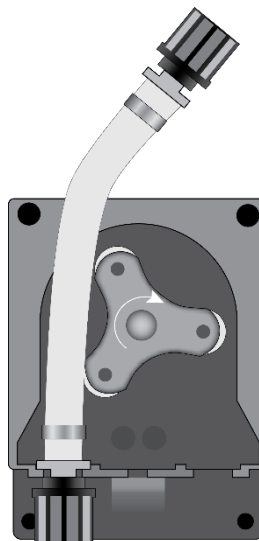

Den linken Anschluss in sein Gehäuse schieben und den Schlauch unter der Läuferführung durchschieben. Den Läufer in Richtung des kreisförmigen Pfeils drehen und dabei gleichzeitig den Schlauch in den Pumpenkopf einführen, bis der rechte Anschluss erreicht wird.

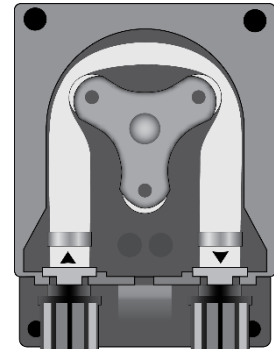

Den Pumpendeckel schließen und fest auf seine Oberfläche drücken, so dass er richtig einrastet.

# Bomba peristáltica PoolOne | Modelos: CS · RG · pH · ORP

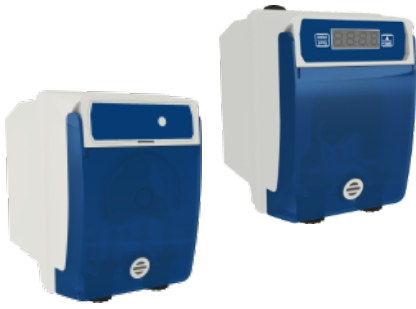

**¡ADVERTENCIA!**

Antes de llevar a cabo CUALQUIER TIPO de trabajo en el interior del panel de control del dispositivo PoolOne, asegúrese de desconectarlo de la fuente de alimentación.

El incumplimiento de las instrucciones recogidas en el presente manual puede ocasionar lesiones a las personas y/o daños al aparato y al sistema.

## 1 CONTENIDO DEL EMBALAJE

			
<b>A:</b> Reductor para válvula de inyección (1/2" M hasta 3/8" H)	<b>B:</b> Cristal PVC 4x6 con tubo de aspiración (4 m)	<b>C:</b> Polietileno tubo de suministro (5 m)	<b>D:</b> Montura de conexión para asegurar PSS3 en el tubo de 2" (φ=50 mm)
			
<b>E:</b> Filtro de fondo (elevador de PP)	<b>F:</b> Válvula labial FPM (3/8" GAS)	<b>G:</b> Soporte de sonda PSS3 (1/2" GAS)	<b>H:</b> Kit del soporte de montaje (φ=tornillos de 6 mm)
			
<b>I:</b> Sonda de pH	<b>J:</b> Sonda ORP	<b>K:</b> Solución tampón pH 7	<b>L:</b> Solución de calibración 465 mv

Modelo Elemento*	PoolOne CS (dosificación constante)	PoolONE RG (Bomba de regulación analógica)	PoolONE RG-DIGIT (Bomba de regulación digital)	PoolOne pH (3.8 – 8.2 pH)	PoolOne ORP (400 – 999 mV)
<b>A</b>	1	1	1	1	1
<b>B</b>	1	1	1	1	1
<b>C</b>	1	1	1	1	1
<b>D</b>	1	1	1	2	2
<b>E</b>	1	1	1	1	1
<b>F</b>	1	1	1	1	1
<b>G</b>	--	--	--	1	1
<b>H</b>	1	1	1	1	1
<b>I</b>	--	--	--	1	--
<b>J</b>	--	--	--	--	1
<b>K</b>	--	--	--	--	1
<b>L</b>	--	--	--	1	--

\* Los valores de la tabla representan el número de elementos que vienen dentro del paquete.

# Bomba peristáltica PoolOne | Modelos: CS · RG · pH · ORP

## ¡ADVERTENCIA!

Estos productos son **PELIGROSOS (I✳A)** y requieren precauciones especiales durante su uso, manipulación y almacenamiento.

- **No mezcle NUNCA productos químicos.**
- No permita NUNCA que niños o personas que no hayan leído este manual usen o manipulen PoolOne o alguno de sus componentes periféricos (incluidos los productos químicos).

### Productos químicos de pH:

- No recomendado **EN ABSOLUTO** => ácido sulfúrico puro
- Recomendado para reducir el pH => pH negativo (con una base de ácido sulfúrico)
- Recomendado para aumentar el pH => pH positivo (carbonato de sodio o bicarbonato)

### Productos químicos ORP:

- No recomendado **EN ABSOLUTO** => cualquier tipo de cloro orgánico
- Puede usarse cloro líquido o lejía al 12% puros. Si el producto tiene una concentración del 48%, es necesario diluirlo en agua en una proporción de 1:3.

Las sondas de pH/ORP están sujetas a desgaste y deterioro, por lo que no están cubiertas por la garantía.

## 2 INSTRUCCIONES DE INSTALACIÓN

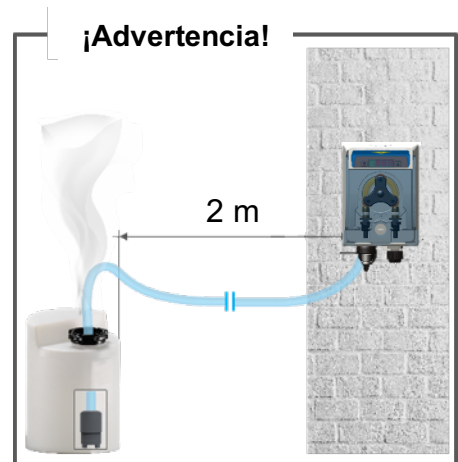
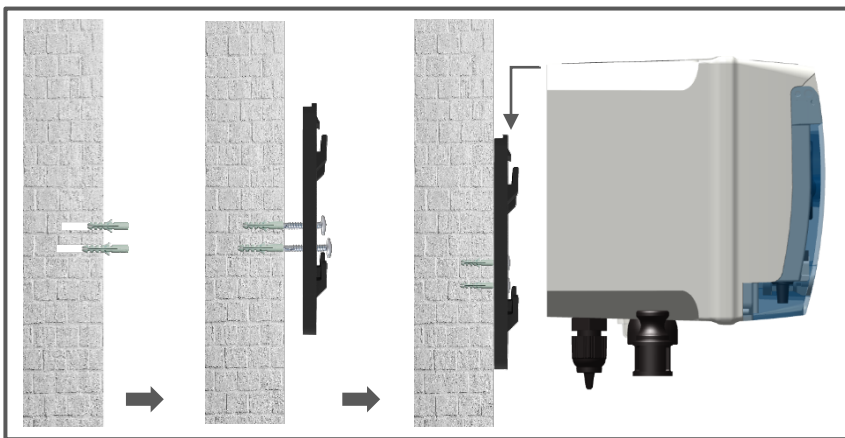

Asegúrese de que la presión de inyección está por debajo de 1,5 bares

### Colocación de la sonda

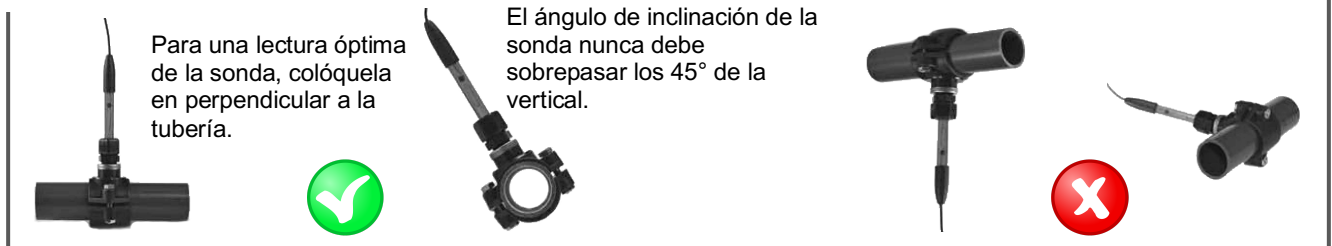

### Planta de instalación

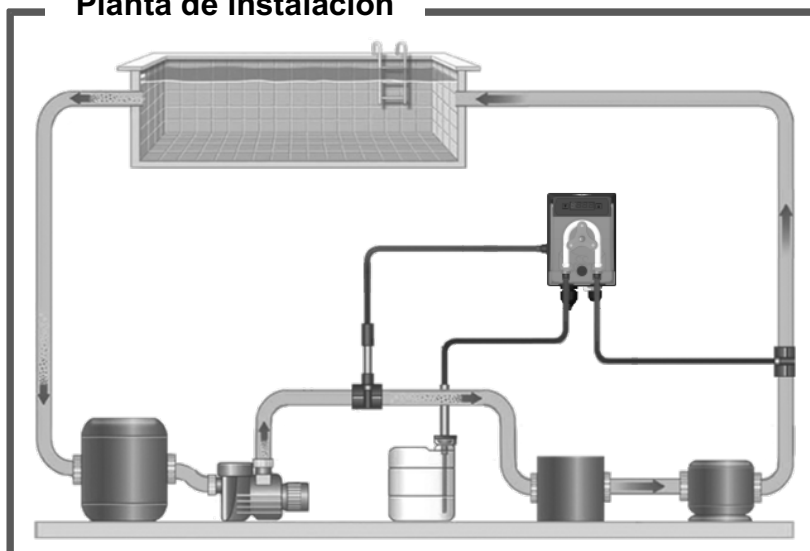

### ¡Advertencia!

#### Usar con clorador salino:

En los sistemas de pH, para evitar el riesgo de que el sistema funcione incorrectamente o se dañe, respete las siguientes instrucciones:

1. Coloque la sonda de medición de pH antes de la célula del clorador.
2. Para eliminar las corrientes inducidas, conecte el agua de la piscina a un punto eléctrico de la puesta a tierra
3. Coloque el punto de inyección de producto tras la célula del clorador.

# Bomba peristáltica PoolOne | Modelos: CS · RG · pH · ORP

## 3 CONEXIONES ELÉCTRICAS

### Diagrama de cableado:

1. Interruptor de tres posiciones: ON-OFF-MOM
2. Cable de alimentación eléctrica
3. entrada de sonda de pH o ORP, con conector BNC
4. Libre

Conecte el cable de alimentación pre-cableado a la red eléctrica (100 ÷ 240 Vca).

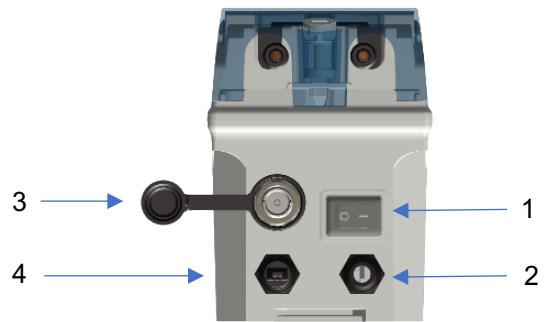

## 4 ESPECIFICACIONES TÉCNICAS

Especificaciones	PoolOne CS	PoolOne pH	PoolOne ORP	PoolOne RG	PoolONE RG-Digit
Intervalo	--	3,2 ÷ 8,2 pH (*1)	400÷999 mV (*1)	--	--
Fiabilidad	--	± 0,02 pH	± 2 mV	--	--
Precisión del dispositivo	--	± 0,1 pH	± 10 mV	--	--
Caudal de la bomba	1,5 o 5 l/h	1,5 l/h	1,5 l/h	4 l/h	De 25 a 9.450 ml/h
Fuente de alimentación	220 - 240 Vca 50/60 Hz				100 ÷ 240 Vca 50/60 Hz
Consumo	9 Vatios				
Método de dosificación	dosificación constante	ON-OFF Punto de ajuste regulable		Ajuste de la dosificación constante mediante trimmer	Ajuste de la dosificación constante mediante dígito
Estado de la bomba	Pausa – Suministro				
Pantalla	Ninguno	4 dígitos con 7 segmentos		Ninguno	4 dígitos con 7 segmentos
Calibración de la sonda	Ninguna	Automática		Ninguna	Ninguna
Contrapresión máx.	1,5 bares				
Peso	1,3 kg				
Dimensiones (A x H x P)	98 x 134 x 118 mm (3,85" x 5,3" x 4,6")				

(\*1) La bomba tiene un aislamiento eléctrico galvanizado y un aislamiento de medición.

### Etiquetas del producto:

1. Código y número de serie
2. Código QR para descargar el manual de instrucciones

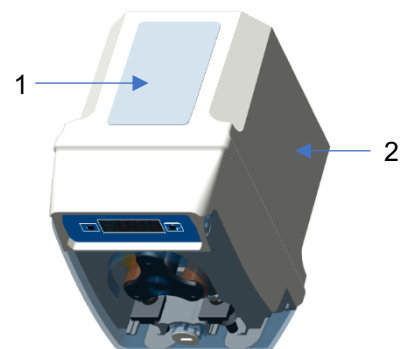

# Bomba peristáltica PoolOne | Modelos: CS · RG · pH · ORP

## 5 CONFIGURACIÓN Y FUNCIONAMIENTO

### 5.1 PoolONE CS

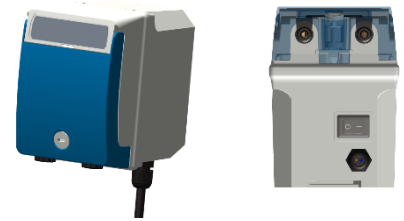

PoolONE CS: bomba de dosificación constante sin regulación de caudal

### 5.2 Bomba analógica PoolONE RG

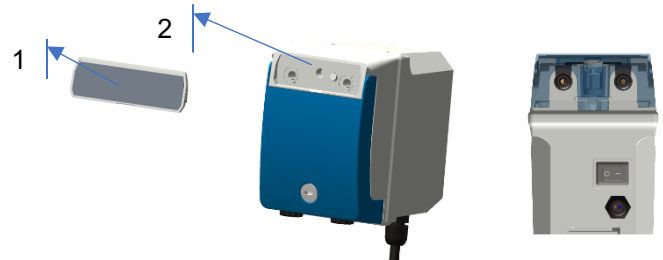

PoolONE RG: bomba de dosificación constante con regulación del caudal mediante trimmer

Quite la cubierta de plástico (1) y ajuste el caudal interviniendo en el trimmer (2).  
El caudal mín. es el 35% del valor máximo.

### 5.3 Bomba DIGITAL PoolOne RG





#### Diagrama de cableado:

1. Interruptor de tres posiciones: ON-OFF-MOM
2. Cable de alimentación eléctrica
3. Entrada de 220-240 VCA de la bomba de circulación
4. Libre



PoolONE RG\_Digit: bomba de dosificación constante con regulación del caudal mediante teclado  
El caudal mín. es el 10% del valor máximo.

#### Posición del interruptor:

- MOM:** Posición de cebado. La bomba funciona durante 3 minutos a la máxima velocidad; presionando de nuevo MOM, el interruptor para la bomba.
- ON (encendida):** Posición normal. La unidad dosifica.  
La bomba empieza a dosificar a la velocidad establecida cuando se detecta un activador externo y se para cuando se deja de detectar el activador externo.  
Para ajustar la velocidad de la bomba, presiones  o  para regular la velocidad entre el 10% y el 100%.
- OFF (apagada):** Posición de espera. La bomba está parada.

# Bomba peristáltica PoolOne | Modelos: CS · RG · pH · ORP

## 5.4 PoolOne pH

Dosificación constante con medidor de control del pH incorporado, la bomba tiene un aislamiento eléctrico galvanizado y un aislamiento de medición.



### Posición del interruptor:

- MOM:** Posición de cebado. La bomba está funcionando.
- ON (encendida):** Posición normal. La unidad mide el pH y dosifica.
- OFF (apagada):** Posición de espera. La bomba está parada.

### Configuración

- Sitúe el interruptor en la posición **OFF**.
- Mantenga presionado el botón **cal** durante 3 segundos para acceder al menú de CONFIGURACIÓN.
- menú de configuración del pH:
  - Configure el método de dosificación para el pH: **Acid** (Ácido) o **Alka** (Alcalino)
  - Temperatura (valor fijo): **25°C**



### Configuración del punto de ajuste

- Sitúe el interruptor en la posición **ON**.
- Mantenga presionado el botón **set** hasta que el valor del punto de ajuste empiece a parpadear; después, presione de nuevo **set** para aumentar el valor.
- Transcurridos 3 segundos desde haber soltado el **set** botón, la unidad guarda el valor y muestra **mem**. Es posible establecer un valor entre 3.2 y 8.2 pH, con un aumento de 0.1 pH. Cuando la medición real es inferior a 3.2 pH o superior a 8.2 pH, la medida mostrada parpadea.

Sitúe el interruptor en la posición **ON**; después siga estos pasos:

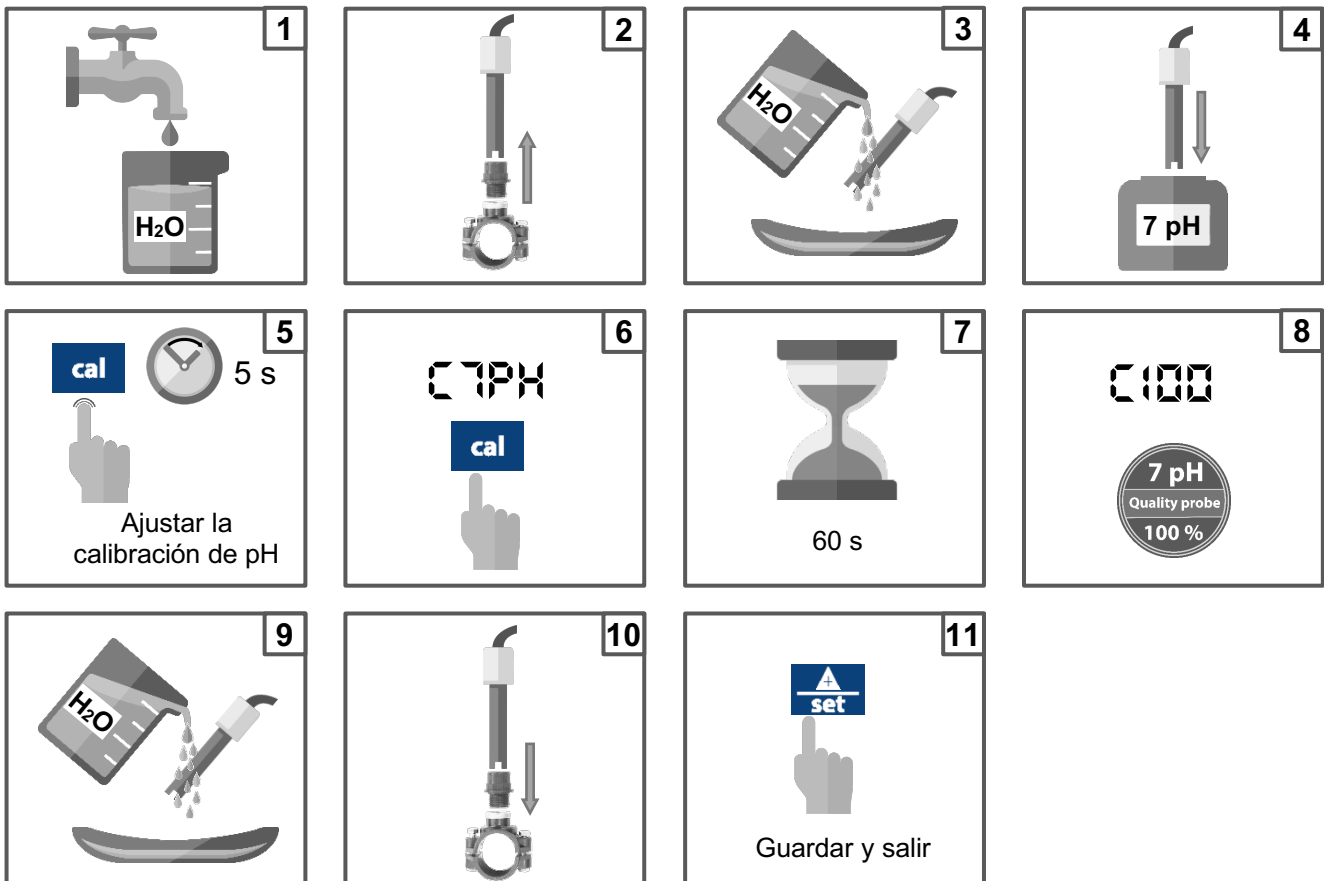

**Nota:** Si ha seleccionado la función EasyCal, la calibración se hará solamente en 1 punto usando la solución tampón de pH 7. Durante el procedimiento de calibración, el LED de espera (configuración) se enciende con luz roja.

# Bomba peristáltica PoolOne | Modelos: CS · RG · pH · ORP

## 5.5 PoolOne ORP

Dosificación constante con medidor de control del pH incorporado, la bomba tiene un aislamiento eléctrico galvanizado y un aislamiento de medición

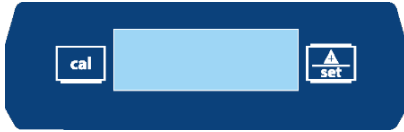

### Posición del interruptor:

- MOM:** Posición de cebado. La bomba está funcionando.
- ON (encendida):** Posición normal. La unidad mide el ORP y dosifica.
- OFF (apagada):** Posición de espera. La bomba está parada.

### Configuración

- Sitúe el interruptor en la posición **OFF**.
- Mantenga presionado el botón **cal** durante 3 segundos para acceder al menú de CONFIGURACIÓN.
- Menú de configuración ORP:
  - Configure el método de dosificación para ORP: **Alto** ("Hi") o **Bajo** ("Lo")
  - Temperatura (valor fijo): **25°C**



### Configuración del punto de ajuste

- Sitúe el interruptor en la posición **ON**.
- Mantenga presionado el botón **set** hasta que el valor del punto de ajuste empiece a parpadear; después, presione de nuevo el botón **set** para aumentar el valor.
- Transcurridos 3 segundos desde haber soltado el botón **set**, la unidad guarda el valor y muestra **mem**. Es posible establecer un valor entre 400 y 999 mV, con un incremento de 10 mV. Cuando la medición real es inferior a 400 mV o superior a 999 mV, la medida mostrada parpadea.

Sitúe el interruptor en la posición **ON**; después siga estos pasos:

 1	 2	 3	 4
 Ajuste la calibración Redox 5	 6	 60 s 7	 8
 9	 10	 Guardar y salir 11	

**Nota:** Durante el procedimiento de calibración, el LED de espera (configuración) se enciende con luz roja.



# Bomba peristáltica PoolOne | Modelos: CS · RG · pH · ORP

## 6 ALARMAS

### 6.1 PoolOne CS

- Alarma

### 6.2 PoolOne pH

- **Alarma OFA**(Alarma sobrealimentación)
- **Flujo**: presencia de flujo de entrada (servidumbre por la bomba del filtro).

### 6.3 PoolOne ORP

- **Alarma OFA**(Alarma sobrealimentación):
- **Flujo**: presencia de flujo de entrada (servidumbre por la bomba del filtro).

- **ALARMA DE NIVEL (OPCIONAL)**

Si la bomba señala una alarma de nivel, la pantalla muestra: **RLR** y el zumbador se activa.

Alarma	PoolOne pH	PoolOne ORP	Acciones que deben realizarse
<b>Medida fuera de rango</b>	<b>888</b> (intermitencia)	<b>888</b> (intermitencia)	<ul style="list-style-type: none"><li>• Sustituya o compruebe la sonda de medición</li><li>• Presione <b>cal</b> para abrir el relé de alarma</li><li>• Restablezca pH / ORP</li></ul>

## 7 MANEJO

### Sustitución de la manguera:

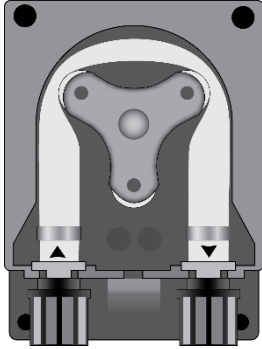

Abra la tapa de la bomba y suelte la manguera tirando del conector izquierdo hacia arriba.

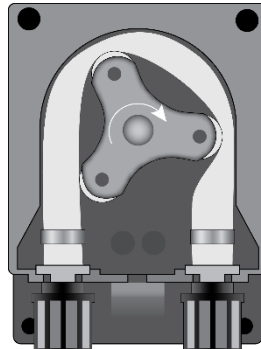

Coloque el carrete a las 7h15, girándolo en la dirección de la flecha circular.

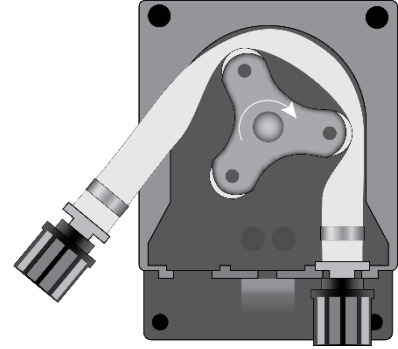

Suelte por completo el conector izquierdo, manteniéndolo tenso hacia el exterior, y gire el carrete en la dirección de la flecha circular para que la manguera quede suelta hasta el conector derecho.

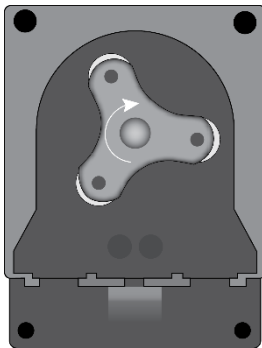

Coloque el carrete a las 7h15 girándolo en la dirección de la flecha circular.

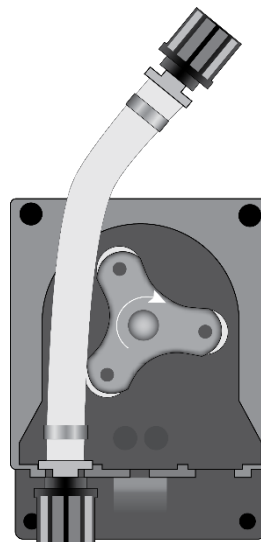

Introduzca el conector izquierdo en el compartimento correspondiente y pase la manguera por debajo de la guía del carrete. Gire el rollo en la dirección de la flecha circular, acompañando al mismo tiempo la manguera dentro del cabezal de la bomba hasta alcanzar el conector derecho.

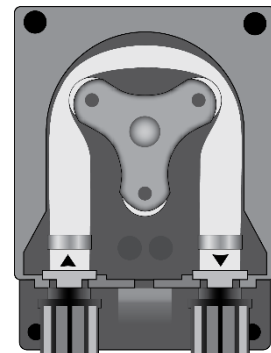

Cierre la tapa de la bomba y presione la superficie fuertemente para que quede correctamente encajada en su sitio.

# PoolOne Peristaltic Pump | Modèles : CS · RG · pH · ORP

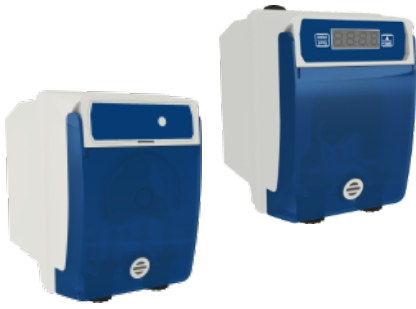

## MISE EN GARDE !

Avant de procéder à TOUTE intervention à l'intérieur du panneau de commande de l'appareil PoolOne, assurez-vous de le débrancher de l'alimentation électrique.

Le non-respect des instructions contenues dans ce manuel peut entraîner des blessures aux personnes et/ou endommager l'appareil et le système.

## 1 CONTENU DE L'EMBALLAGE

 <b>A</b> : Réducteur pour Clapet d'injection PVDF (1/2" M vers 3/8" F)	 <b>B</b> : Cristal PVC 4x6 avec tuyau d'aspiration (4 m)	 <b>C</b> : Tuyau d'alimentation en polyéthylène (5m)	 <b>D</b> : Sellette de fixation pour fixer le PSS3 sur un tuyau de 2" (φ=50 mm)
 <b>E</b> : Filtre au pied (Rehausse PP)	 <b>F</b> : Vanne à lèvres FPM (3/8" GAZ)	 <b>G</b> : Porte-sonde PSS3 (GAZ 1/2")	 <b>H</b> : Kit de support de montage (φ=vis 6 mm)
 <b>I</b> : sonde pH	 <b>J</b> : Sonde ORP	 <b>K</b> : solution tampon pH 7	 <b>L</b> : Solution d'étalonnage 465 mv

Modèle Élément*	PoolOne CS (dosage constant)	PoolONE RG (Pompe de réglage analogique)	PoolONE RG-DIGIT (Pompe de réglage numérique)	PoolOne pH (3,8 – 8,2 pH)	PoolOne ORP (400 – 999 mV)
<b>A</b>	1	1	1	1	1
<b>B</b>	1	1	1	1	1
<b>C</b>	1	1	1	1	1
<b>D</b>	1	1	1	2	2
<b>E</b>	1	1	1	1	1
<b>F</b>	1	1	1	1	1
<b>G</b>	---	---	---	1	1
<b>H</b>	1	1	1	1	1
<b>I</b>	---	---	---	1	---
<b>J</b>	---	---	---	---	1
<b>K</b>	---	---	---	---	1
<b>L</b>	---	---	---	1	---

\* Les valeurs du tableau représentent le nombre d'éléments contenus à l'intérieur du paquet.

# PoolOne Peristaltic Pump | Modèles : CS · RG · pH · ORP

## MISE EN GARDE !

Ces produits sont **DANGEREUX (I✘A)** et requièrent des précautions particulières lors de leur utilisation, leur manipulation et leur stockage.

- **NE JAMAIS mélanger les produits chimiques.**
- **NE JAMAIS** laisser des enfants ou des personnes qui n'ont pas lu ce manuel, utiliser ou manipuler PoolOne ou l'un de ses composants périphériques (y compris les produits chimiques).

### Produits chimiques concernant le pH :

- **ABSOLUMENT** non recommandé => acide sulfurique pur
- Recommandé pour abaisser le pH => pH négatif (avec une base d'acide sulfurique)
- Recommandé pour élever le pH => pH positif (carbonate ou bicarbonate de sodium)

### Produits chimiques concernant l'ORP :

- **ABSOLUMENT** non recommandé => tous les types de chlore organique
- Du chlore liquide ou de l'eau de Javel à 12 % peuvent être utilisés à l'état pur. Si le produit a une concentration de 48 %, il est nécessaire de le diluer dans l'eau dans un rapport 1:3.

Les sondes pH/ORP sont sujettes à l'usure et ne sont donc pas couvertes par la garantie.

## 2 INSTRUCTIONS D'INSTALLATION

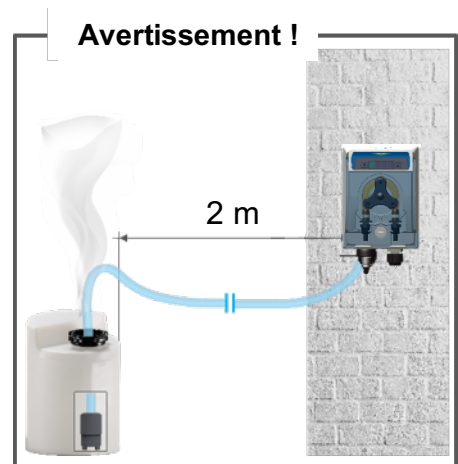
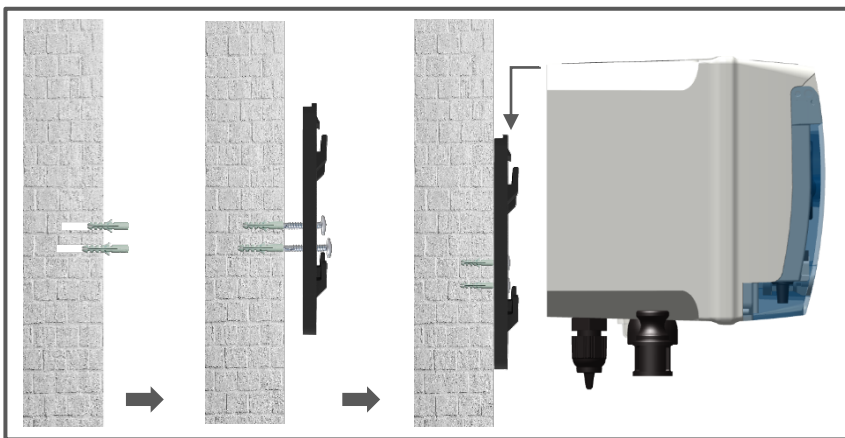

Assurez-vous que la pression d'injection est inférieure à 1,5 bar

### Positionnement de la sonde



Pour un relevé optimal de la sonde, positionnez-la perpendiculairement au tuyau.



L'angle d'inclinaison de la sonde ne doit jamais dépasser 45° par rapport à la verticale.



### Unité d'installation

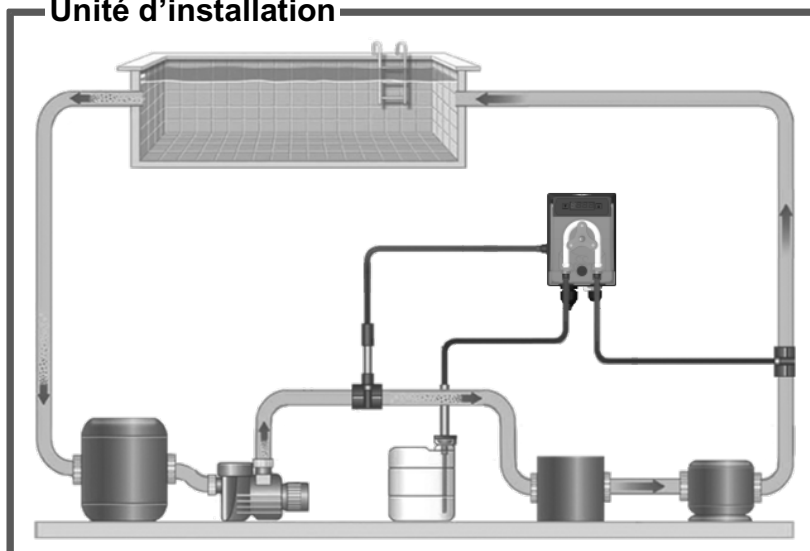

### Avertissement !

#### Utilisation avec l'électrolyseur au sel :

Pour les systèmes de pH, pour éviter le risque de dysfonctionnement ou d'endommagement, respecter les instructions suivantes :

1. Placer la sonde de mesure du pH en amont de la cellule de l'électrolyseur.
2. Pour éliminer les courants de Foucault, brancher l'eau de la piscine sur un point de masse électrique
3. Placez le point d'injection du produit en aval de la cellule de l'électrolyseur.

# PoolOne Peristaltic Pump | Modèles : CS · RG · pH · ORP

## 3 RACCORDEMENTS ELECTRIQUES

Schéma de câblage :

1. Interrupteur à trois positions : ON-OFF-MOM
2. Câble d'alimentation électrique
3. Entrée de sonde pH ou ORP, avec connecteur BNC
4. Libre

Branchez le câble d'alimentation électrique pré-câblé au réseau (100 ÷ 240 Vca).

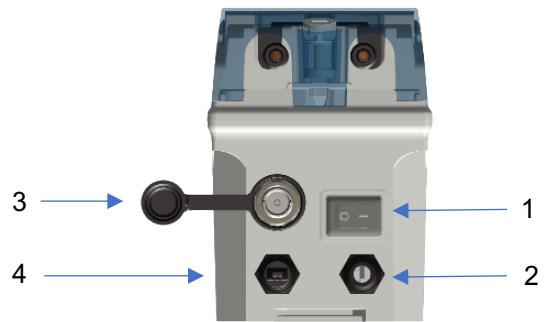

## 4 SPECIFICATIONS TECHNIQUES

Spécifications	PoolOne CS	PoolOne pH	PoolOne ORP	PoolOne RG	PoolONE RG-Digit
Plage	---	3,2 ÷ 8,2 pH (*1)	400÷999 mV (*1)	---	---
Précision	---	± 0,02 pH	± 2 mV	---	---
Précision de l'appareil	---	± 0,1 pH	± 10 mV	---	---
Débit pompe	1,5 ou 5 l/h	1,5 l/h	1,5 l/h	4 l/h	25 à 9450 ml/h
Alimentation électrique	220 - 240 Vca 50/60 Hz				100 ÷ 240 Vca 50/60 Hz
Consommation	9 Watt				
Méthode de dosage	Dosage constant	ON-OFF Point de consigne réglable		Réglage du dosage constant par trimmer	Dosage constant ajusté par chiffre
État de la pompe	Pause - Alimentation				
Écran	Aucun	4 chiffres avec 7 segments		Aucun	4 chiffres avec 7 segments
Étalonnage de sonde	Aucun	Automatique		Aucun	Aucun
Contre-pression max.	1,5 bar				
Poids	1,3 kg				
Dimensions (L-H-P)	98 x 134 x 118 mm (3,85" x 5,3" x 4,6")				

(\*1) La pompe est dotée d'une isolation électrique galvanisée et mesure l'isolation.

Étiquettes Produit :

1. Code et numéro de série
2. Code QR pour télécharger le manuel d'instructions complet.

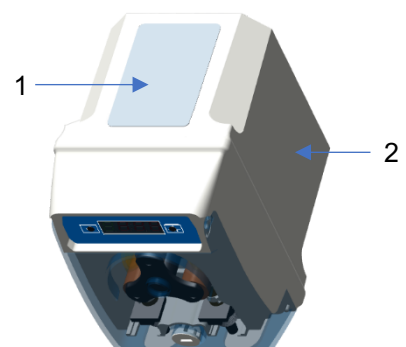

# PoolOne Peristaltic Pump | Modèles : CS · RG · pH · ORP

## 5 INSTALLATION ET FONCTIONNEMENT

### 5.1 PoolONE CS

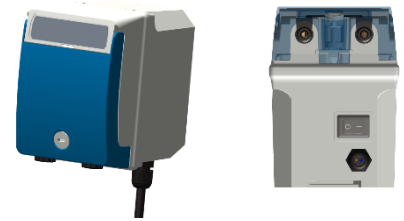

PoolONE CS : pompe de dosage constant sans réglage du débit

### 5.2 Pompe analogique PoolONE RG

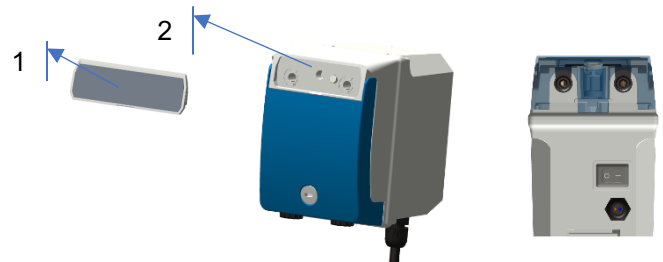

PoolONE RG : pompe de dosage constant avec réglage du débit par trimmer

Enlever le couvercle en plastique (1) et régler le débit à l'aide du trimmer (2).  
Le débit minimal est de 35 % de la valeur maximale.

### 5.3 Pompe RG-DIGITAL PoolOne



#### Schéma de câblage :

1. Interrupteur à trois positions : ON-OFF-MOM
2. Câble d'alimentation électrique
3. Pompe de circulation entrée 220-240 VCA
4. Libre

PoolONE RG-Digit : pompe de dosage constant avec réglage du débit par clavier  
Le débit minimal est de 10 % de la valeur maximale.

#### Position de l'interrupteur :

- MOM** : Position d'amorçage. La pompe fonctionne pendant 3 minutes à vitesse maximale ; une nouvelle pression sur l'interrupteur MOM arrête la pompe.
- ON (Allumée)** : Position normale. L'unité dose.  
La pompe commence à doser à la vitesse définie lorsqu'un déclencheur externe est détecté et arrête le dosage lorsque le déclencheur externe n'est pas détecté.  
Pour régler la vitesse de la pompe, appuyer sur ▼ ou ▲ pour ajuster la vitesse de 10 à la vitesse maximale 100 %.
- OFF (Éteinte)** : Position d'attente. La pompe est arrêtée.

# PoolOne Peristaltic Pump | Modèles : CS · RG · pH · ORP

## 5.4 PoolOne pH

Dosage constant grâce à un pH-mètre intégré, la pompe est dotée d'une isolation électrique galvanisée et d'une isolation de mesure.



### Position de l'interrupteur :

- MOM** : Position d'amorçage. La pompe est en marche.
- ON (Allumé)** : Position normale. L'unité mesure le pH et dose.
- OFF (Éteinte)** : Position d'attente. La pompe est arrêtée.

### Configuration

- Mettre l'interrupteur en position **OFF** (Éteint).
- Maintenir le bouton **cal** enfoncé pendant 3 secondes pour entrer dans le menu SETUP (CONFIGURATION).
- Menu de configuration du pH :
  - Régler la méthode de dosage en fonction du pH : **Acide** ou **Alka**
  - Température (valeur fixe) : **25°C**

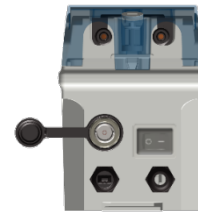

### Réglage du point de consigne

- Mettre l'interrupteur en position **ON** (Allumé).
- Maintenir **set** enfoncé jusqu'à ce que la valeur du point de consigne commence à clignoter, puis appuyer à nouveau sur **set** pour augmenter la valeur.
- Au bout de 3 secondes après avoir relâché la touche **set**, l'unité enregistre la valeur et affiche **mem**. Il est possible de fixer une valeur entre 3,2 et 8,2 pH, avec une augmentation de 0,1 pH. Lorsque la mesure réelle est inférieure à 3,2 pH ou supérieure à 8,2 pH, la mesure affichée clignote.

Mettre l'interrupteur en position **ON** (Allumé) puis suivre les étapes ci-dessous :

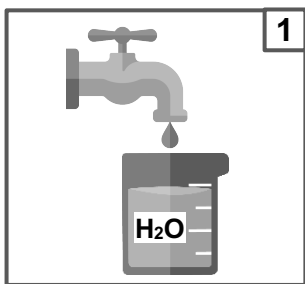
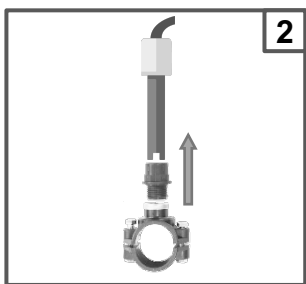
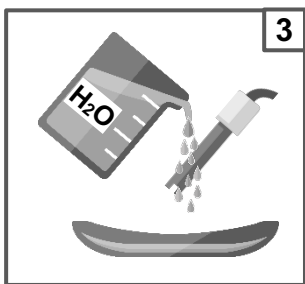
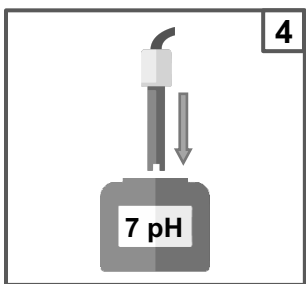
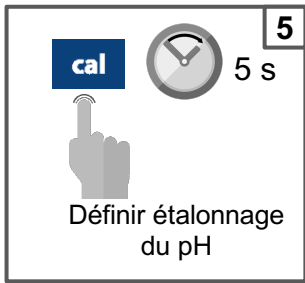
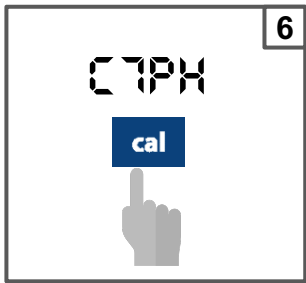
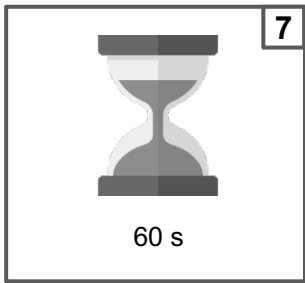
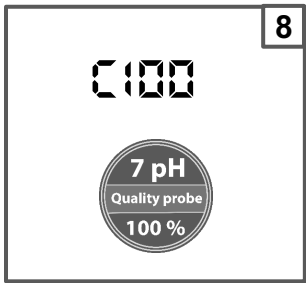
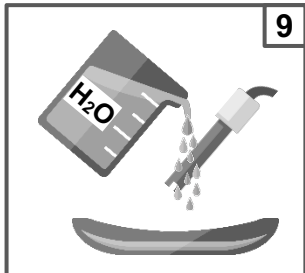
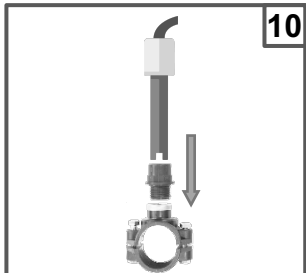
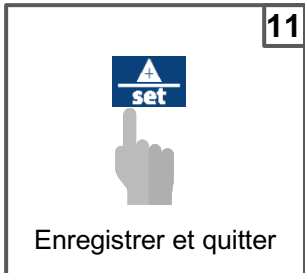
 <b>1</b>	 <b>2</b>	 <b>3</b>	 <b>4</b>
 <b>5</b> Définir étalonnage du pH	 <b>6</b>	 <b>7</b> 60 s	 <b>8</b>
 <b>9</b>	 <b>10</b>	 <b>11</b> Enregistrer et quitter	

**Remarque** : Si vous avez sélectionné la fonction EasyCal, l'étalonnage sera effectué uniquement sur 1 point à l'aide de la solution tampon à 7 pH. Pendant la procédure d'étalonnage, la LED **maintien (configuration)** s'allume en rouge.

# PoolOne Peristaltic Pump | Modèles : CS · RG · pH · ORP

## 5.5 PoolOne ORP

Dosage constant grâce à un pH-mètre intégré, la pompe est dotée d'une isolation électrique galvanisée et d'une isolation de mesure



### Position de l'interrupteur :

- MOM** : Position d'amorçage. La pompe est en marche.
- ON (Allumée)** : Position normale. L'unité mesure l'ORP et dose.
- OFF (Éteinte)** : Position d'attente. La pompe est arrêtée.

### Configuration



- Mettre l'interrupteur en position **OFF** (Éteint).
- Maintenir le bouton **cal** enfoncé pendant 3 secondes pour entrer dans le menu SETUP (CONFIGURATION).
- Menu de configuration de l'ORP :
  - Régler la méthode de dosage en fonction de l'ORP : **Haut** (« Hi ») ou **Bas** (« Lo »)
  - Température (valeur fixe) : **25°C**



### Réglage du point de consigne

- Mettre l'interrupteur en position **ON** (Allumé).
- Maintenir le bouton **set** enfoncé jusqu'à ce que la valeur du point de consigne commence à clignoter, puis appuyer à nouveau sur **set** pour augmenter la valeur.
- Au bout de 3 secondes après avoir relâché la touche **set**, l'unité enregistre la valeur et affiche **mem**. Il est possible de fixer une valeur entre 400 et +999 mV, avec une augmentation de 10 mV. Lorsque la mesure réelle est inférieure à 400 mV ou supérieure à 999 mV, la mesure affichée clignote.

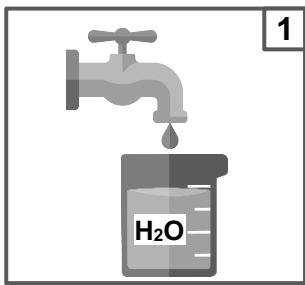
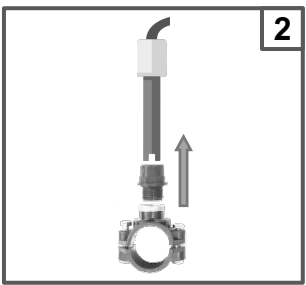
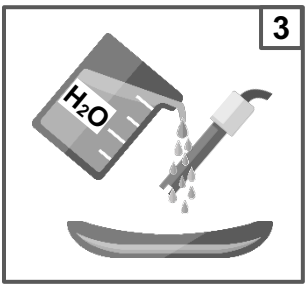
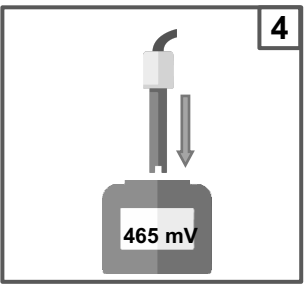
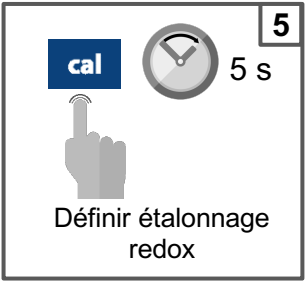
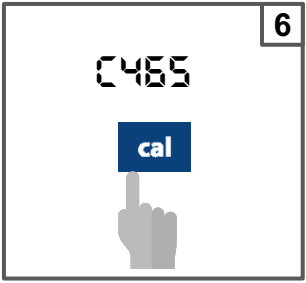
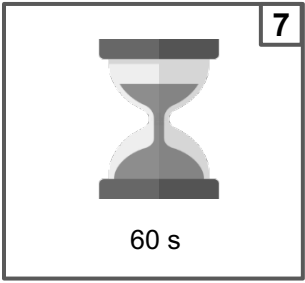
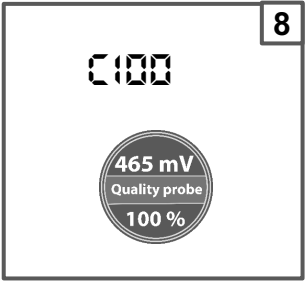
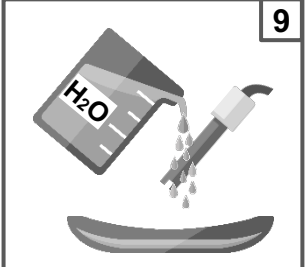
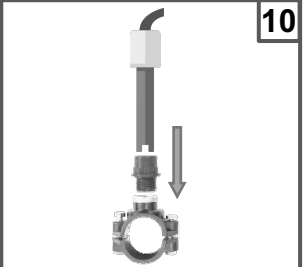
Mettre l'interrupteur en position **ON** (Allumé) puis suivre les étapes ci-dessous :

 <b>1</b>	 <b>2</b>	 <b>3</b>	 <b>4</b>
 <b>5</b> Définir étalonnage redox	 <b>6</b>	 <b>7</b> 60 s	 <b>8</b>
 <b>9</b>	 <b>10</b>	 <b>11</b> Enregistrer et quitter	

**Remarque** : Pendant la procédure d'étalonnage, la LED **maintien (configuration)** s'allume en rouge.



## 6 ALARMES

### 6.1 PoolOne CS

- Alarme

### 6.2 PoolOne pH

- **Alarme OFA** (Alarme de suralimentation)
- **Débit** : présence d'un débit entrant (asservissement par la pompe de filtration).

### 6.3 PoolOne ORP

- **Alarme OFA** (Alarme de suralimentation) :
- **Débit** : présence d'un débit entrant (asservissement par la pompe de filtration).

- **ALARME DE NIVEAU (EN OPTION)**

Si la pompe signale une alarme de niveau, l'écran s'affiche : **RLR** et l'avertisseur sonore s'allume.

Alarme	PoolOne pH	PoolOne ORP	Actions à réaliser
Mesure hors plage	■■■■ (clignotant)	■■■■ (clignotant)	<ul style="list-style-type: none"><li>• Remplacer ou vérifier la sonde de mesure</li><li>• Appuyer sur <b>cal</b> pour ouvrir le relais d'alarme</li><li>• Restaurer pH / ORP</li></ul>

## 7 MANUTENTION

### Remplacement du tuyau :

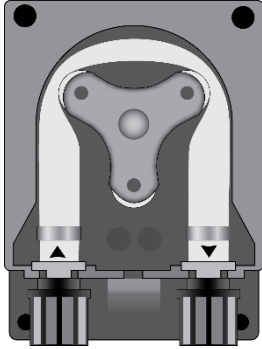

Ouvrez le couvercle de la pompe et libérez le tuyau en tirant sur le connecteur gauche vers le haut.

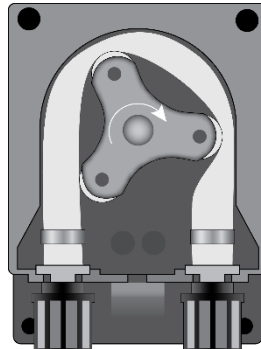

Placez le rouleau à 7h15, en le tournant dans le sens de la flèche circulaire.

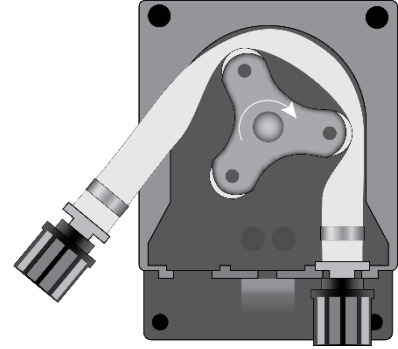

Libérez complètement le connecteur gauche, en le maintenant tendu vers l'extérieur, et tournez le rouleau dans le sens de la flèche circulaire de sorte que le tuyau soit libéré du connecteur droit.

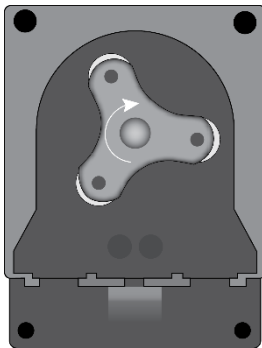

Placez le rouleau à 7h15, en le tournant dans le sens de la flèche circulaire.

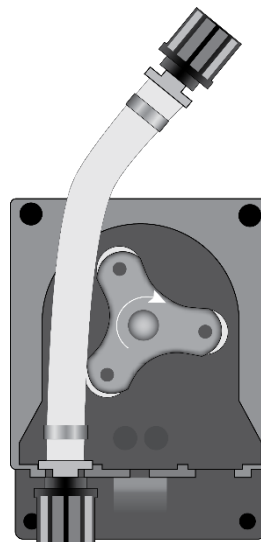

Insérer le connecteur gauche dans le boîtier correspondant et faire passer le tuyau sous le guide du rouleau. Tourner le rouleau dans le sens de la flèche circulaire, en accompagnant simultanément le tuyau dans la tête de la pompe, jusqu'à atteindre le connecteur droit.

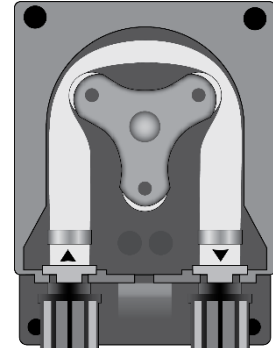

Fermer le couvercle de la pompe et appuyer fermement sur sa surface pour qu'elle soit correctement verrouillée en place.

# PoolOne Pompa peristaltica | Modelli: CS · RG · pH · ORP



## AVVERTENZA!

Prima di effettuare QUALSIASI operazione all'interno del pannello di controllo del dispositivo PoolOne, assicurarsi di averlo scollegato dalla rete di alimentazione.

Il mancato rispetto delle istruzioni contenute nel presente manuale può causare lesioni a persone e/o danni al dispositivo e al sistema.

## 1 CONTENUTO DELLA CONFEZIONE

 <b>A:</b> Riduttore per valvola di iniezione (1/2" M - 3/8" F)	 <b>B:</b> PVC trasparente 4x6 con tubo di aspirazione (4 m)	 <b>C:</b> Tubo di mandata in polietilene (5m)	 <b>D:</b> Staffa per fissaggio del PSS3 sul tubo da 2" (φ=50 mm)
 <b>E:</b> Filtro di fondo (montante in PP)	 <b>F:</b> valvola a labbro FPM (3/8" GAS)	 <b>G:</b> porta sonda PSS3 (1/2" GAS)	 <b>H:</b> Kit staffe di montaggio (φ=viti da 6 mm)
 <b>I:</b> sonda pH	 <b>J:</b> sonda ORP	 <b>K:</b> Soluzione tampone pH 7	 <b>L:</b> Soluzione di calibrazione 465 mV

Modello / Componente*	PoolOne CS (dosaggio costante)	PoolONE RG (pompa a regolazione analogica)	PoolONE RG-DIGIT (pompa a regolazione digitale)	PoolOne pH (3.8 – 8.2 pH)	PoolOne ORP (400 – 999 mV)
A	1	1	1	1	1
B	1	1	1	1	1
C	1	1	1	1	1
D	1	1	1	2	2
E	1	1	1	1	1
F	1	1	1	1	1
G	---	---	---	1	1
H	1	1	1	1	1
I	---	---	---	1	---
J	---	---	---	---	1
K	---	---	---	---	1
L	---	---	---	1	---

\* I valori riportati nella tabella rappresentano il numero di componenti contenuti nella confezione.

# PoolOne Pompa peristaltica | Modelli: CS · RG · pH · ORP

## AVVERTENZA!

Questi prodotti sono **PERICOLOSI (I★A)** e richiedono precauzioni speciali durante l'uso, la manipolazione e lo stoccaggio.

- **Non miscelare MAI i prodotti chimici.**

- Non permettere MAI a bambini o a persone che non abbiano letto il presente manuale di utilizzare o manomettere PoolOne o i suoi componenti periferici (inclusi i prodotti chimici).

### Prodotti chimici pH:

- **ASSOLUTAMENTE** sconsigliato => acido solforico puro
- Consigliato per abbassare il pH => pH negativo (con una base di acido solforico)
- Consigliato per aumentare il pH => pH positivo (carbonato o bicarbonato di sodio)

### Prodotti chimici ORP:

- **ASSOLUTAMENTE** sconsigliato => tutti i tipi di cloro organico
- È possibile utilizzare cloro liquido o candeggina al 12% puri. Se la concentrazione del prodotto è del 48%, sarà necessario diluirlo in acqua con un rapporto di 1:3.

Le sonde pH / ORP sono soggette a usura e pertanto non sono coperte dalla garanzia.

## 2 ISTRUZIONI PER L'INSTALLAZIONE

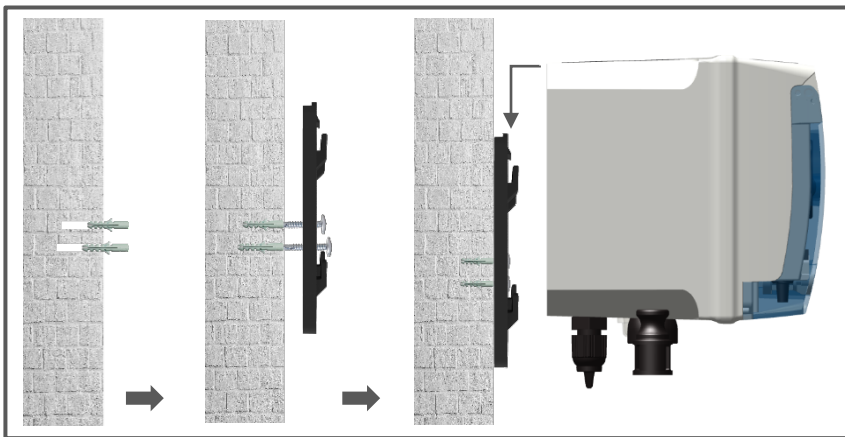

Verificare che la pressione di iniezione sia inferiore a 1,5 bar

### Posizionamento della sonda

Per una lettura ottimale della sonda, posizionarla perpendicolarmente al tubo.



L'angolo di inclinazione della sonda non deve mai essere superiore a 45° dalla verticale.



### Impianto di installazione

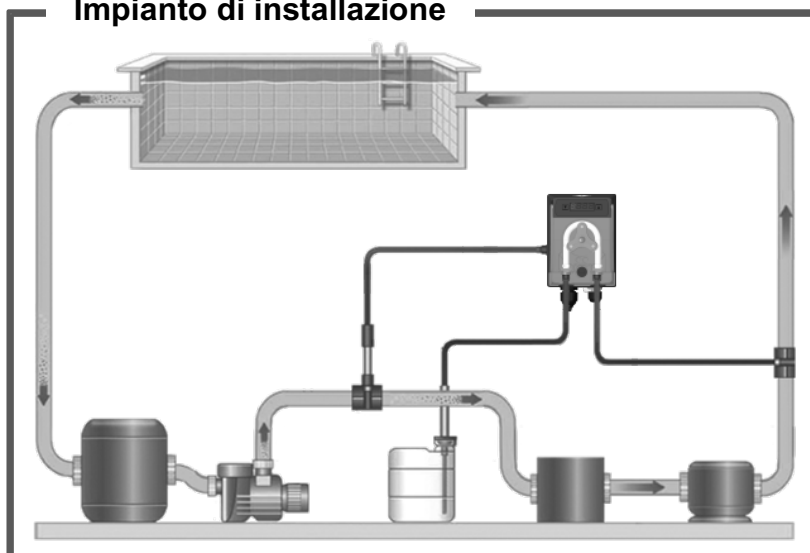

### Avvertenza!

**Usare con generatore di cloro a sale:**

Per evitare rischi di malfunzionamento o danneggiamento dei sistemi pH, rispettare le istruzioni riportate di seguito:

1. Posizionare la sonda di misurazione del pH prima della cella del generatore di cloro.
2. Per eliminare le eventuali correnti parassite, collegare l'acqua della piscina a una massa elettrica.
3. Collocare il punto di iniezione del prodotto dopo la cella del generatore di cloro.

# PoolOne Pompa peristaltica | Modelli: CS · RG · pH · ORP

## 3 COLLEGAMENTI ELETTRICI

### Schema di cablaggio:

1. Interruttore a tre posizioni: ON-OFF-MOM
2. Cavo di alimentazione
3. Ingresso sonda pH o ORP, con connettore BNC
4. Libero

Collegare il cavo di alimentazione precablato alla rete elettrica (100 ÷ 240 Vac).

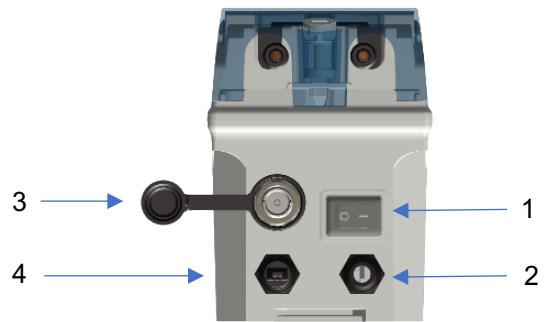

## 4 SPECIFICHE ELETTRICHE

Specifiche	PoolOne CS	PoolOne pH	PoolOne ORP	PoolOne RG	PoolONE RG-Digit
Intervallo	---	3.2 ÷ 8.2 pH (*1)	400÷999 mV (*1)	---	---
Precisione	---	± 0,02 pH	± 2 mV	---	---
Precisione del dispositivo	---	± 0,1 pH	± 10 mV	---	---
Portata della pompa	1,5 o 5 l/h	1,5 l/h	1,5 l/h	4 l/h	25 - 9450 ml/h
Alimentazione	220 - 240 Vac 50/60 Hz				100 ÷ 240 Vac 50/60 Hz
Consumo	9 Watt				
Metodo di dosaggio	Dosaggio costante	ON-OFF Setpoint regolabile		Regolazione dosaggio costante tramite trimmer	Regolazione dosaggio costante digitale
Stato pompa	Pausa - Alimentazione				
Display	Nessuno	4 cifre con 7 segmenti		Nessuno	4 cifre con 7 segmenti
Calibrazione della sonda	Nessuno	Automatico		Nessuno	Nessuno
Contropressione max.	1,5 bar				
Peso	1,3 kg				
Dimensioni (L-H-P)	98 x 134 x 118 mm (3,85 x 5,3 x 4,6 pollici)				

(\*1) La pompa presenta un isolamento elettrico zincato e di misura isolata.

### Etichetta prodotto:

1. Codice e numero di serie
2. Codice QR per scaricare il manuale d'istruzioni completo.

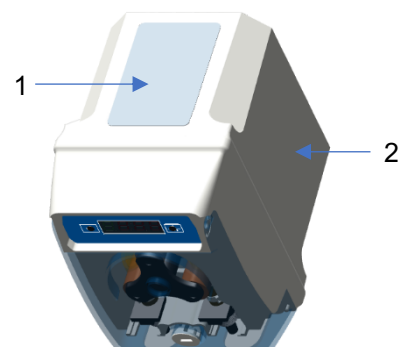

## 5 IMPOSTAZIONE E FUNZIONAMENTO

### 5.1 PoolONE CS

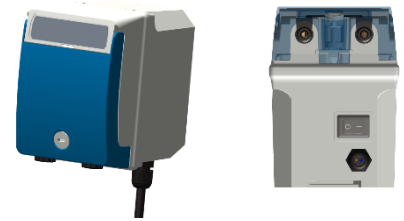

PoolONE CS: pompa a dosaggio costante senza regolazione della portata

### 5.2 Pompa analogica PoolONE RG

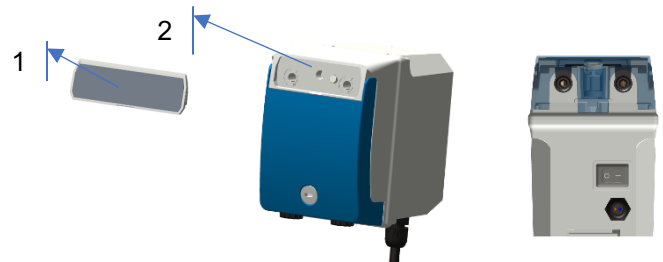

PoolONE RG: pompa a dosaggio costante con regolazione di portata tramite trimmer

Rimuovere il coperchio di plastica (1) e regolare la portata tramite il trimmer (2).  
La portata minima è del 35% del valore massimo.

### 5.3 Pompa PoolOne RG-DIGITAL



#### Schema di cablaggio:

1. Interruttore a tre posizioni: ON-OFF-MOM
2. Cavo di alimentazione
3. Ingresso pompa di ricircolo a 220-240 VAC input
4. Libero

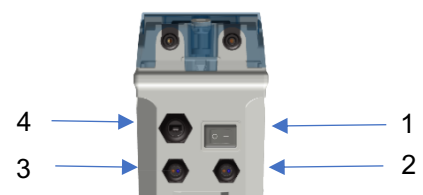

PoolONE RG-Digit: pompa a dosaggio costante con regolazione di portata tramite tastiera  
La portata minima è del 10% del valore massimo.

#### Posizione interruttore:

- MOM:** Posizione di adescamento. La pompa funziona per 3 minuti alla velocità massima. Premendo di nuovo l'interruttore MOM la pompa si arresta.
- ON:** Posizione normale. L'unità esegue il dosaggio.  
La pompa inizia a dosare alla velocità impostata quando viene rilevato un azionamento esterno. Quando invece questo non viene rilevato, la pompa interrompe il dosaggio.  
Per impostare la velocità della pompa, premere ▼ o ▲ per regolarla da 10 a max. 100%.
- OFF:** Posizione di stand-by. La pompa si ferma.

# PoolOne Pompa peristaltica | Modelli: CS · RG · pH · ORP

## 5.4 PoolOne pH

Dosaggio costante con misuratore di controllo del pH integrato, la pompa presenta un isolamento elettrico zincato e di misura isolata.



### Posizione interruttore:

- MOM:** Posizione di adescamento. La pompa è in funzione.
- ON:** Posizione normale. L'unità misura il pH ed esegue il dosaggio.
- OFF:** Posizione di stand-by. La pompa si ferma.

### Configurazione

- Portare l'interruttore in posizione **OFF**.
- Tenere premuto il pulsante **cal** per 3 secondi per accedere al menu di configurazione (SETUP).
- Menu di configurazione del pH:
  - Regolazione del metodo di dosaggio per il pH: **Acido** o **Basico**
  - Temperatura (valore fisso): **25°C**

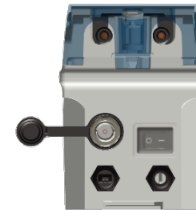

### Regolazione del setpoint

- Portare l'interruttore in posizione **ON**.
- Tenere premuto **set** fin quando il valore di setpoint inizia a lampeggiare, quindi premere di nuovo **set** per aumentare il valore.
- Una volta rilasciato il pulsante **set**, dopo 3 secondi, l'unità salva il valore e mostra la scritta **mem**. È possibile impostare un valore compreso tra 3,2 e 8,2 pH, con incrementi di 0,1 pH. Quando la misurazione effettiva è inferiore a 3,2 pH o superiore a 8,2 pH, la misura visualizzata lampeggia.

Portare l'interruttore in posizione **ON**, quindi seguire la procedura seguente:

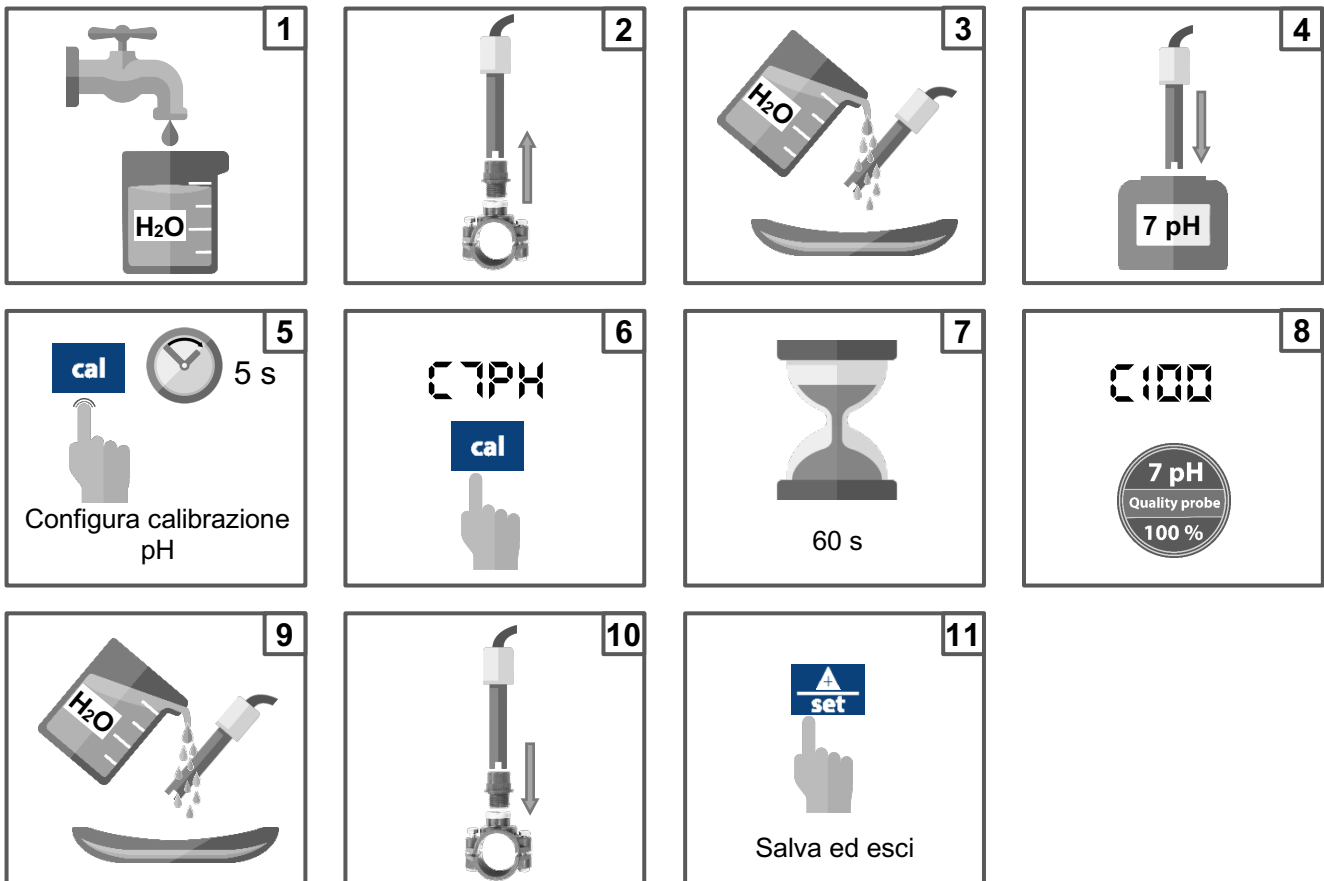

**Nota:** Selezionando la funzione EasyCal, la calibrazione verrà effettuata solo in 1 punto utilizzando la soluzione tampone con pH 7.

# PoolOne Pompa peristaltica | Modelli: CS · RG · pH · ORP

Durante la procedura di calibrazione, il LED di configurazione hold diventerà rosso.

## 5.5 PoolOne ORP

Dosaggio costante con misuratore di controllo del pH integrato, la pompa presenta un isolamento elettrico zincato e di misura isolata.



### Posizione interruttore:

- MOM:** Posizione di adescamento. La pompa è in funzione.
- ON:** Posizione normale. L'unità misura l'ORP ed esegue il dosaggio.
- OFF:** Posizione di stand-by. La pompa si ferma.

### Configurazione

- Portare l'interruttore in posizione **OFF**.
- Tenere premuto il pulsante **cal** per 3 secondi per accedere al menu di configurazione (SETUP).
- Menu di configurazione ORP:
  - Regolazione del metodo di dosaggio per l'ORP: **Alto** ("Hi") o **Basso** ("Lo")
  - Temperatura (valore fisso): **25°C**



### Regolazione del setpoint

- Portare l'interruttore in posizione **ON**.
- Tenere premuto **set** fin quando il valore di setpoint inizia a lampeggiare, quindi premere di nuovo **set** per aumentare il valore.
- Una volta rilasciato il pulsante **set**, dopo 3 secondi, l'unità salva il valore e mostra la scritta **mem**. È possibile impostare un valore compreso tra 400 e +999 mV, con incrementi di 10 mV. Quando la misurazione effettiva è inferiore a 400 mV o superiore a 999 mV, la misura visualizzata lampeggia.

Portare l'interruttore in posizione **ON**, quindi seguire la procedura seguente::

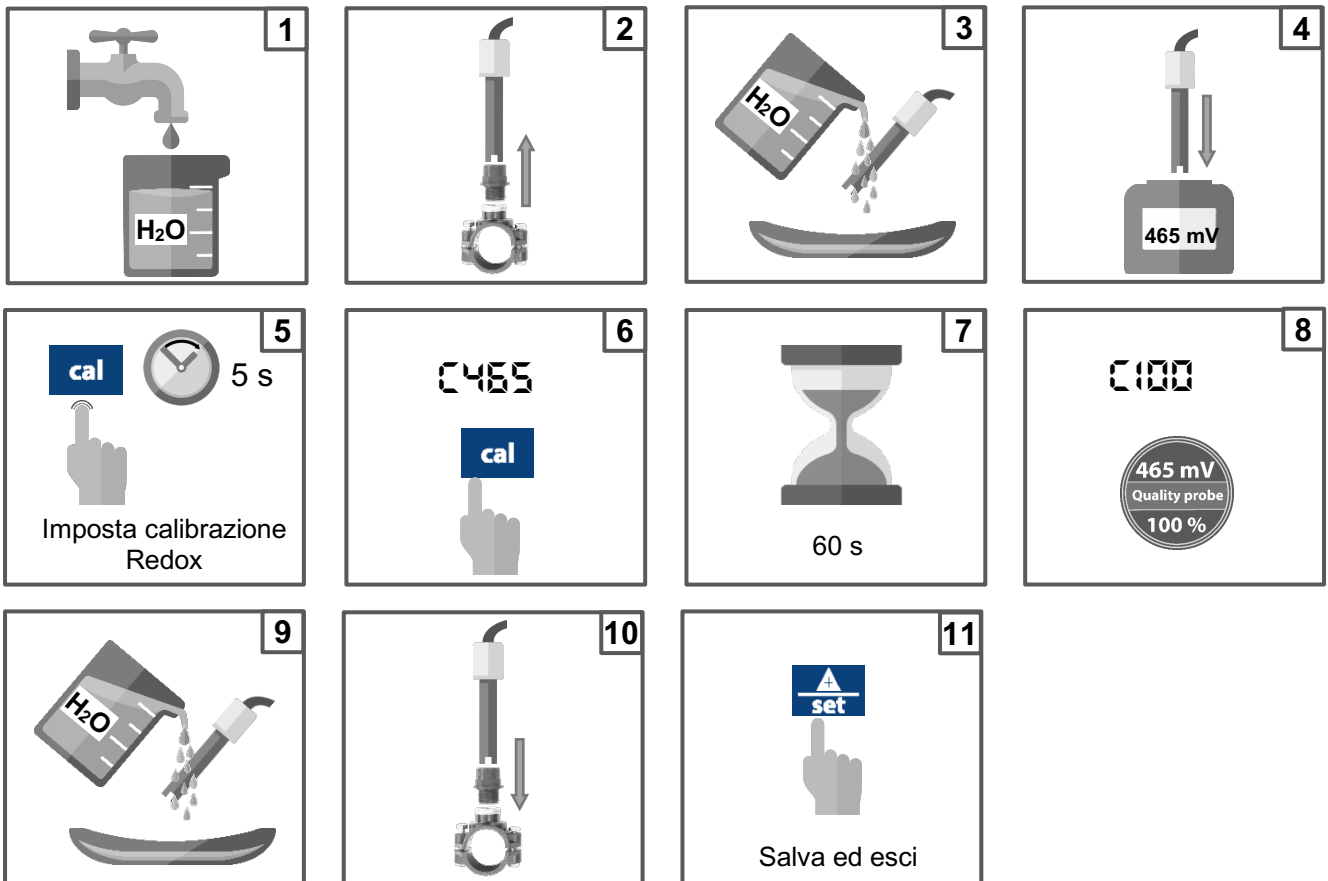

**Nota:** Durante la procedura di calibrazione, il LED di configurazione **hold** diventerà rosso.



## 6 ALLARMI

### 6.1 PoolOne CS

- Allarme

### 6.2 PoolOne pH

- **Allarme OFA** (Allarme di sovralimentazione)
- **Flow (Flusso)**: presenza di flusso in entrata (asservimento dalla pompa di filtraggio).

### 6.3 PoolOne ORP

- **Allarme OFA** (Allarme di sovralimentazione):
- **Flow (Flusso)**: presenza di flusso in entrata (asservimento dalla pompa di filtraggio).
- **ALLARME DI LIVELLO (OPZIONALE)**  
Se la pompa segnala un allarme id livello, il display mostra: **RLR** e l'avvisatore acustico si attiva.

Allarme	PoolOne pH	PoolOne ORP	Azioni da eseguire
<b>Misura fuori intervallo</b>	<b>888</b> (lampeggiante)	<b>888</b> (lampeggiante)	<ul style="list-style-type: none"><li>• Sostituire o controllare la sonda di misura</li><li>• Premere <b>cal</b> per aprire il relè allarmi</li><li>• Ripristinare pH / ORP</li></ul>

## 7 MOVIMENTAZIONE

### Sostituzione dei tubi:

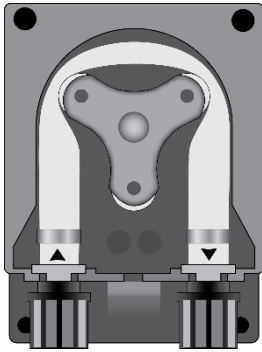

Aprire il coperchio della pompa e rilasciare il tubo tirando il connettore di sinistra verso l'alto.

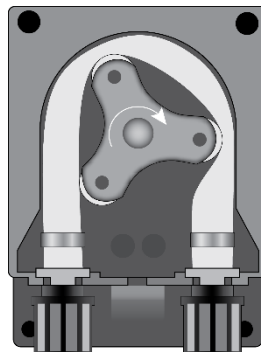

Posizionare il rullo alle ore 7:15, ruotandolo nella direzione della freccia circolare.

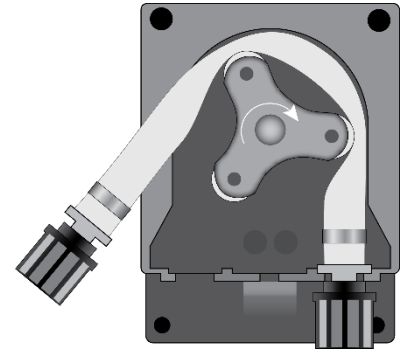

Rilasciare completamente il connettore di sinistra, tenendolo teso verso l'esterno, e ruotare il rullo nella direzione della freccia circolare in modo da liberare il tubo verso il connettore di destra.

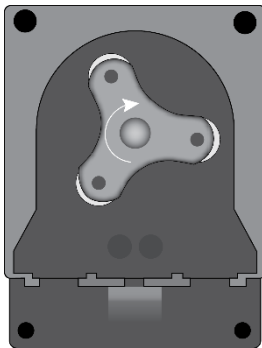

Posizionare il rullo alle ore 7:15, ruotandolo nella direzione della freccia circolare.

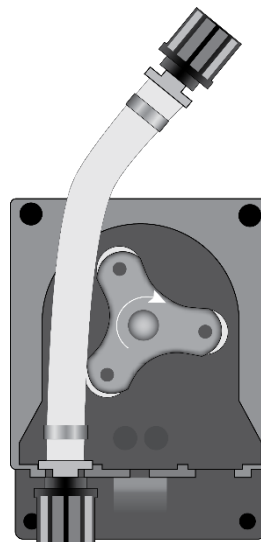

Inserire il connettore di sinistra nell'apposito alloggiamento e far passare il tubo sotto la guida del rullo. Ruotare il rullo nella direzione della freccia circolare, accompagnando contemporaneamente il tubo nella testata della pompa fino a raggiungere il connettore di destra.

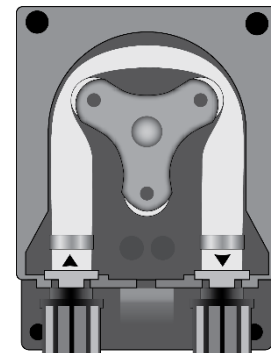

Chiudere il coperchio della pompa e premere sulla superficie in modo da bloccarlo saldamente in posizione.